



Version:07/2018-C2
Document No:DQP05000005



VRN-Q6

Ultrasonic Scaler (Ultrasonic Periodontal Therapy System)

OPERATION MANUAL

Contents

1	Product Overview	4
2	Product Functions and Operations	13
3	Sterilization and Maintenance	17
4	Contraindication	22
5	Storage and Maintenance	23
6	Transportation	23
7	Product List	23
8	After Service	24
9	Symbol Instruction	25
10	Environmental Protection	26
11	Manufacturer's Right	26
12	Electromagnetic Compatibility	26
13	Attachedtable:Power Table of Tip	34

Copyright Notice

Copyright URIT Medical Electronic Co.,Ltd.All Rights Reserved.

Thank you for buying VRN-Q6 Ultrasonic scaler (Ultrasonic Periodontal Therapy System). It will bring the all new experience and feeling to you. All of the latest information before printing is included in the instruction manual. URIT Medical Electronic Co.,Ltd. has full charge of revising the specification and reserves the right to modify it at any time without notice. Some pictures in this specification is shown for reference only, all products as per the material subjects.

URIT Medical Electronic Co.,Ltd. copyrights this specification. No part of this specification may be reproduced in any form or means, without the prior written consent of URIT Medical Electronic Co.,Ltd. Operation of this product should be in concordance with relative standards and regulations of Department for Medicaid Services. The use of this device solely to qualified, trained and competent dental health practitioners or under their supervision. Before using this product, make sure the instruction manual has been carefully studied. URIT Medical Electronic Co.,Ltd. accepts no liability for injury or damage resulting from improper use, arising in particular through non-observance of the instruction manual.

In order to keep the handpiece in good working condition, it is necessary to maintain the handpiece regularly, and use the handpiece on the machine at least once a month, and keep it dry after use.

The tip of the wrench can be sterilized by high temperature and high pressure, refer to 3.

The product cannot be disassembled privately. If necessary, please disassemble and repair it under the authorization of the company. The repair is limited to the replacement of the tail line, main board, and water pump.

The circuit diagrams, parts lists, instructions, calibration instructions and other information provided in the manual can be used by companies or individuals authorized by the company to repair the products.

Please carefully read this User Manual before use and properly keep it for future reference. All operations must be

carried out in strict accordance with the operating instructions of this User Manual. Otherwise, URIT Medical Electronic CO., Ltd. will not be responsible for any errors and product damage caused by illegal operation.



Note:

- **URIT Medical Electronic CO., Ltd. does not promise the products to be used for certain special purposes, or make any implied guarantee for their marketability and applicability. If you need the support of after-sales service, please contact URIT Medical Electronic CO., Ltd. or its authorized agent.**
- **WARNING: Do not modify this equipment without authorization of the manufacturer.**
- **The ultrasonic scaler must be connected to a power adapter, which is a part of the ultrasonic scaler.**

Product Overview

1. Overview

VRN-Q6 Ultrasonic Periodontal Therapy System, equipped with multifunctional piezoelectric ceramic ultrasonic generator and intelligent sandblasting system, is recommended for Perio, Scaling, Endo, Restorative treatments. It also has the following features:

- The scaler tip is casted from Titanium alloy to ensure circular vibration track and more concentrated amplitude, so that Perio, Scaling, Endo, Restorative treatments can be done simultaneously.
- Smart electronics allows extremely wide power ranger with 16 grades from low energy delivery in endodontics too powerful scaling.
- Two large refillable bottles, to satisfy using pure water or disinfectant.
- The hydraulic routing is made from antiseptic material. Disinfectant For the treatment, such as hydrogen peroxide, chlorhexidine, sodium hypochlorite can be filled into the automatic water supply system.
- Detachable handpiece can be 135 °C and 0.22 MPa autoclave sterilization.
- The design electrovalve, making water better controlled and operation more convenient.
- The evolutionary wireless foot pedal remotes the main unit, and the cord foot pedal can also be selected according to user's needs.
- Soft bright LED light improves the clinical efficiency.

1.1 Product composition and principle

Ultrasonic Periodontal Therapy System consists of electronic controlling circuit, sand cylinder, Dental sandblasting powder, gas circuit, liquid route, handpiece, sandblasting nozzle, tips, endodontic files, wireless foot pedal and cord foot pedal.

The principle of ultrasonic periodontal treatment is: the use of high-frequency and high-energy vibration generated by ultrasonic waves to break the surface of the teeth, calculus and dental stains in the periodontal pockets through the working head of the ultrasonic scaler, and then the scale is generated by the scaler The water

mist washed away the gravel and plaque.

The principle of sandblasting is to use compressed air to transport sand powder particles such as sodium bicarbonate and fine quartz from the sand storage tank to the surface of the teeth, and use its mechanical and chemical effects to remove the residual calculi and pigments on the teeth, and achieve The effect of polishing the tooth surface.

1.2 Applicable Scope

- Applicable for periodontal and polishing treatments to clean calculus, plaque and tartar on the surface of tooth and in periodontal pockets, used for root canal disinfection.
- Applicable people: people except for contraindications.
- Place of use: professional dental clinics and hospitals.

1.3 Technical Specifications

- Period of use: 10 years
- Input Voltage: 100V-240V~, 50/60 Hz
- Supply Voltage: DC30V 1.3 A
- Battery of Wireless Foot Pedal: 1.5 V two AA batteries.
- Receiving Sensitivity -114dB (compliance with Telecommunication Act of China) Receiving frequency 2.4GHz ISM band.
- The recommended atmospheric pressure for the product is 70kPa ~ 106kPa, and the water pressure is 0.01Mpa ~ 0.5Mpa. Working state, air consumption is 2CFM, maximum water consumption is 50mL/min. Water bottle outlet pressure is 0.02Mpa.
- Primary Tip Vibration Excursion: minimum: 1 μm deviation: -50%
maximum: 100 μm deviation: + 50%
- Half-excursion Force: minimum: 0.1 N deviation: -50%
maximum: 2 N deviation: + 50%
- Tip Vibration Frequency: 28 KHz ± 3 KHz

- Input Power: 30 VA~48 VA
- Output Power: 3 W~20 W
- Fuse: T1AL 250 V
- Intake Pressure: 5 bar~6 bar(0.5 MPa~0.6 Mpa)
- Specifications of Sandblasting Powder: The size of sand blasting power which act on gingival is 40 μm-65 μm; act on subgingival is 25 μm.

- Weight of Main Unit: 1.5 kg
- Weight of Power Adapter: 0.25 kg
- Dimension in mm(Hx Mx D): 310x370x 170
- Operation Mode: Continuous operation
- Type of Electric Shock Protection: Class II
- Capacity of Electric Shock Protection: Applied part, Type B
- Degree of protection against harmful ingress of water: Ordinary equipment(IPX0)
Protection against water (used on the foot pedal):(IPX1).

• Security Degree in the Presence of Inflammable Anaesthetics or Gases mixed with air or Nitrous Oxide: Not AP or APG Type.

- Operating Conditions:
 - a) Ambient temperature:5 °C ~40°C
 - b) Relative Humidity:≤80% , Atmospheric Pressure:75KPa~ 106KPa.
 - c) Supply Voltage:100 V-240V~ ,50~60 Hz.
 - d) Wireless Foot Pedal:

• Wireless foot switch: transmission frequency: 2.412 Ghz - 2.462 Ghz, modulation type: GFSK, Max. radiation power: 10dBm.

Radio Frequency Interface Requirements - Related to European installation

- Note: This equipment has been tested and found to comply with the limits for a EN 300 440 v2.1.1receiver Category 3.
- These limits are designed to provide reasonable protection against harmful interference in a residential

installation.

• This equipment is sensitive to other equipment that intentionally generates, radio frequency energy in the 2402~2483.5MHz that may conduce to the instability to use the Remote Control on it. However there is no guarantee that interference will not occur in a particular installation. If this equipment suffer from the harmful, interference from another radio device to radio this can be determined by turning the respective equipment off and on, the user is encouraged to try to correct the interference by one or more of the following measures:

- Turn off the disturbance equipment
- Increase the separation between the disturbance equipment
- Consult the dealer or an experienced radio/TV technician for help.

1.4 Components and Functions

1.4.1 Normal View

a) The front and back sketch map of the main unit

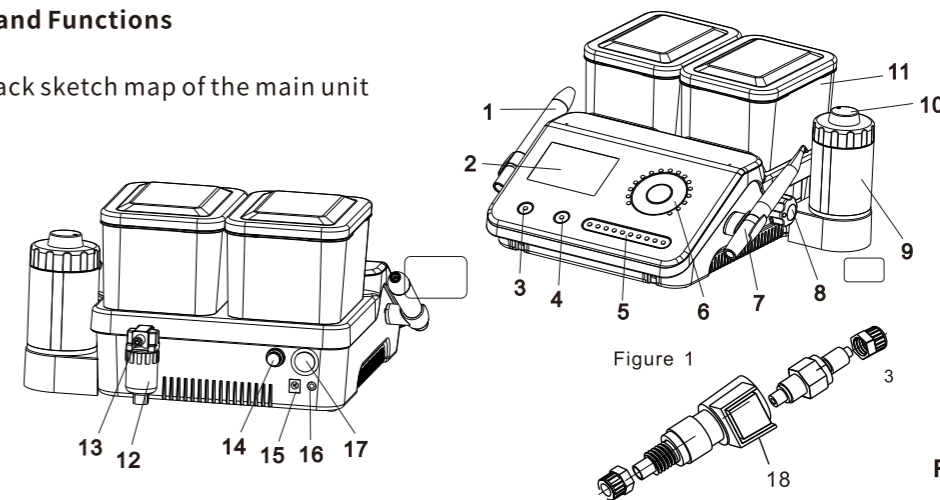

Figure 1

Figure 1

Figure 1: Front view

1. Scaling Handpiece

2. LCD screen

3. Mode Selection Button:

Optionally in “Scaling work” mode:

G Scaling Treatment

P Perio Treatment

E Endo Treatment

A Sandblasting Mode

4. Liquid Bottles Selection Button

5. Water volume control slider

6. Turn power control slider regulate power. Product will clean gas circuit automatically for 5 seconds if power control slider turned in “surface polishing” mode.

7. Sandblasting Handpiece

8. Air Pressure Control Knob

9. Sand Cylinder

10. Sand control knob

11. Water Supply Bottle(s)

Figure 2: Back view

12. Air/Water Separator

13. Air Intake

14. Tubular Fuse

15. Socket for DC Power Adapter

16. Socket for Wired Foot Pedal

17. Power Switch

18. Check Valve Quick Coupling

b) Installation diagram of tip and root canal tip

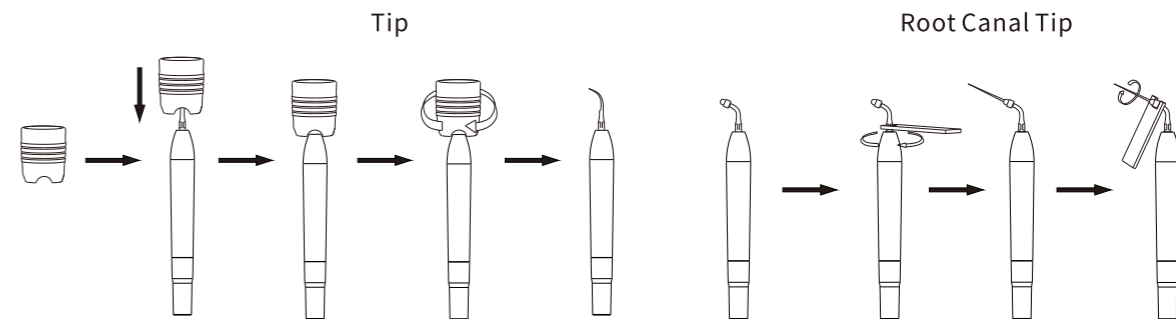

Figure 2

c) Attaching and disassembling the sandblasting nozzle and the subgingival nozzle

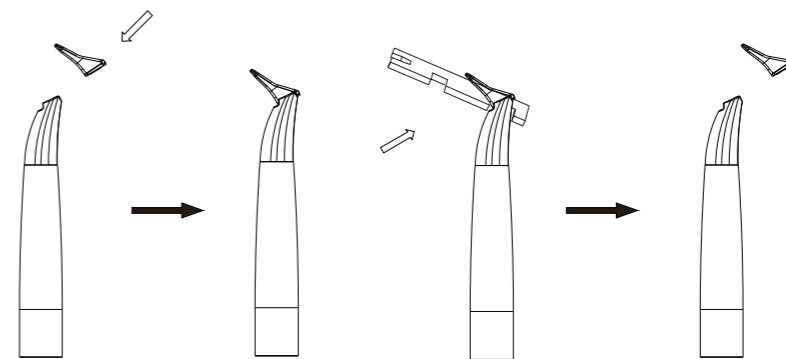

Figure 3

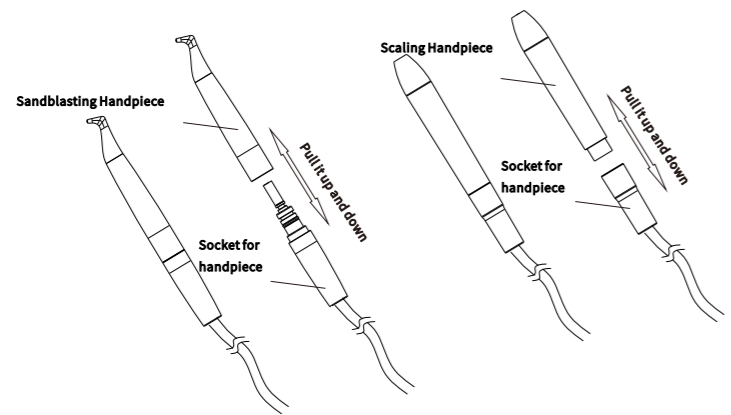

Figure 4

d) Installation for the Battery of Wireless Foot Pedal
 Take off the sticker, and stick the waterproof rubber on the bottom.

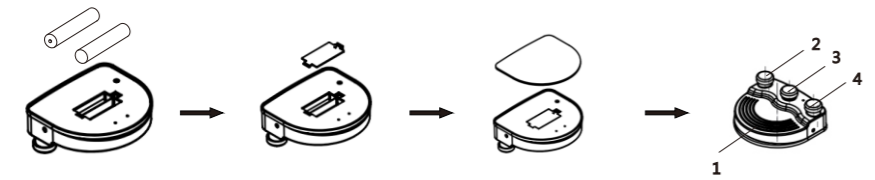

Figure 5

1:Reset botton 2:Reduce pedal power botton 3:Select botton 4:Increase pedal power botton

e) Wireless Foot Pedal Code Reset Process

1. Power state, press "Mode" and "Liquid: L/R" and "Min" of water volume control slider, until the screen displays "Wireless foot pedal code matching status";
2. Ensure that the pedal is pressed, load two AA batteries(It needs to the pedal is pressed continuously).
3. At this point, the power control slider starts to flash, waiting for 30 seconds or rebooting, and then it can be operated normally.

f) Sockets for Air Intake and Power Adapter

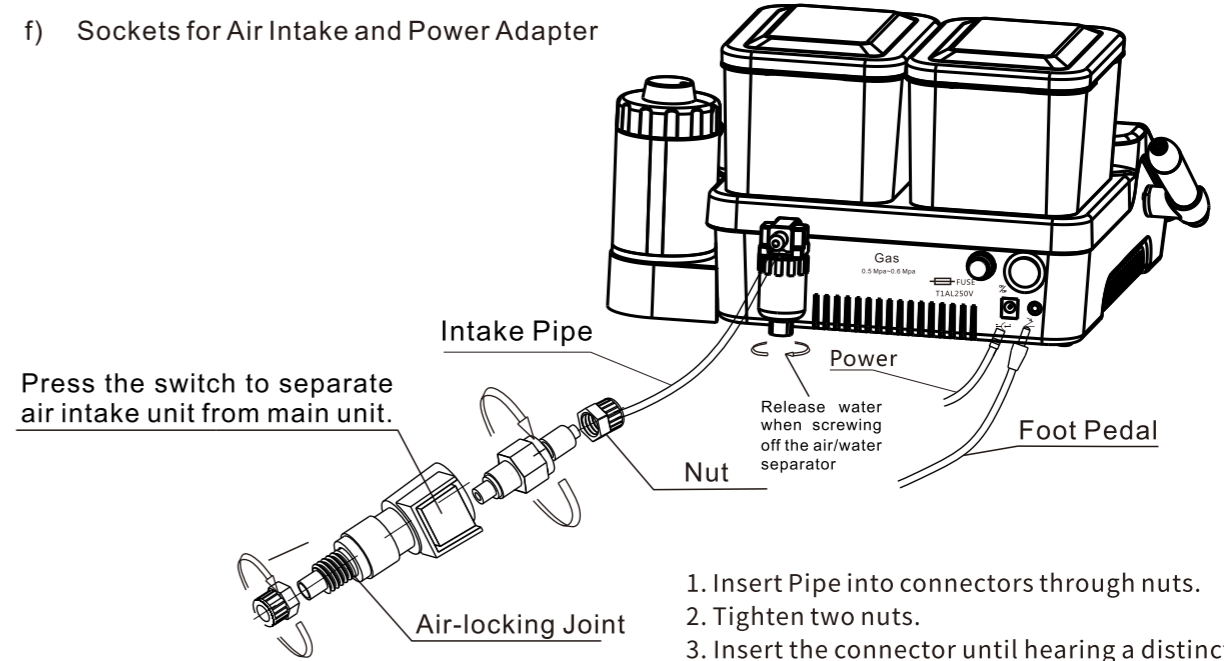

1. Insert Pipe into connectors through nuts.
 2. Tighten two nuts.
 3. Insert the connector until hearing a distinct click.
- Press the switch to separate air intake unit from main unit.

Figure 6

g)Control of Water and Sand Consumption

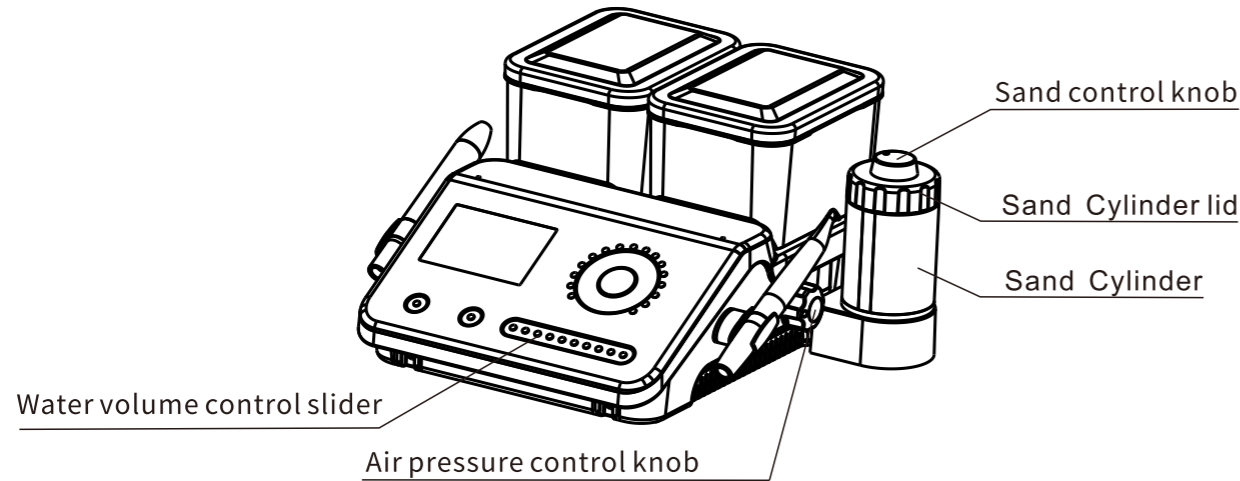

Figure 7

1. Rotate water volume control slider to control the water volume.
2. Rotate sand control knob to control sand consumption.
3. Rotate air pressure control knob to control the air pressure. The product has the function of detecting air pressure, you can read the information about air pressure gear in the panel screen.
4. Keep sand cylinder dry to avoid wet gravel agglomeration.
5. The maximum scale must not be exceeded when the blasting powder is loaded into the sand cylinder.

2 Product Functions and Operations

2.1 Ultrasonic Scaling and Ultrasonic Periodontal Treatment

2.1.1 Operations

- 1) Take the main unit out of the box and put it on a stable plane.
- 2) Install the battery into wireless foot pedal, or insert the plug of the wired foot pedal into the main unit.
- 3) Liquid circuit installation: Fill up appropriate amount of purified water into the water supply bottle, and then insert the water supply bottle to the main unit.
- 4) Gas circuit installation: Connect external source gas to the air intake.
- 5) Fasten the tip to the handpiece with wrench, and then correctly socket the handpiece with the handpiece tail wire socket. Before installing the handpiece, dry the handpiece connection and the tail wire socket thoroughly.
- 6) Make sure that the power switch on the main unit is off. Insert the plug of the power source to the main unit, and then connect the power.
- 7) Turn on the power switch of the main unit, and the LCD screen is on. The left bottle is used by default.
- 8) The frequency during the normal working state is extremely high. Ensure that the tip is in normal working state, only light touch and reciprocating movement at a certain speed can eliminate tartar, and there is no obvious heating at the tip; avoid excessive local force or stay too long when cleaning teeth.
- 9) Vibration intensity: Adjust the vibration intensity as required, generally to a medium vibration intensity, or adjust the vibration intensity at any time during the clinical process according to the patient's sensitivity and the hardness of the calculus.
- 10) Water Consumption adjust: Step on the foot pedal, and the tip begins to vibrate, and then adjust the water volume control slider to form spray to cool down the handpiece and clean the teeth.
- 11) After finishing operation, keep the device working for 30 seconds on the water supply condition in order to clean the handpiece and the tip. Please sterilize them follow the sterilize requirements, please refer to the Article 3.1 for detail.

2.1.2 Scaling Function

Screw the regular tip tightly to handpiece by wrench. Press Mode selection button and select G to clean teeth.

2.1.3 Periodontal Treatment Function

Screw the titanium alloy tip tightly to handpiece by wrench. Press Mode selection button and select P to conduct periodontal treatment.



Notices:

- **Do not pull out the handpiece when the foot pedal is stepped on and the product is producing ultrasonic vibration. Please uninstall the battery if not using the wireless foot pedal for long time.**
- **Choose the appropriate power according to different types of tip (refer to Chapter 13).**
- **The temperature of tip may reach to 122°C once water spray not supplied when continuous operated at the ambient 35°C, Do not touch it until it cools down.**

2.1.4 Instruction of Wrench Using (See figure 2)

The wrench's structure is designed in special way which can control the strength of the scaling tip's installation properly and correctly. It also can guarantee the operator screw or unscrew the scaling tip effectively and keep their hands away from being scratched.

Operation step:

- 1) Put the tip into the wrench and hold the handpiece tightly, rotate the tip in a clockwise direction till the tip does not turn round anymore, and then it is installed.
- 2) Unload the tip: Hold the handpiece and rotate the tip in a counter-clockwise direction by wrench to remove it.
- 3) Once after using, please put the wrench into sterilization cabinet to sterilize.

2.2 Endodontics Function

Operation step:

- 1) Fix endodontic tip clamper to handpiece by endo wrench, unscrew the nut on the clamper.
- 2) Put the tip into the hole in front of clamper, tighten up the clamper nut by wrench.

3) Press Mode selection button and select M. Put the tip into the patients's root canal slowly, and step on the foot pedal to start endo irrigation. During the treatment, turn up the power gradually according to the needs.

4) Please clean and sterilize the tip, handpiece and wrench after use.



Notices:

- **When fixing clamper, it must be tightened up.**
- **The nut on the clamper must be tightened up.**
- **Do not press it too much during endo irrigation for root canal.**
- **Do not step on the foot pedal until the tip is in root canal.**
- **The power range of endo treatment is advised from the 1st to the appropriate grade.**
- **Operators must be trained doctors or technicians; it must do a good job of protection according to hospital requirements during treatment.**

2.3 Surface Polishing Function

1) Pick up the blasting tail line, the system will automatically switch to the blasting mode, at this time the display shows A mode. Without picking up the teeth cleaning and sandblasting handle, short press the M button, you can also enter the A mode.

2) Fasten the subgingival blasting nozzle to the blasting handpiece (this operation is not performed during the supragingival sandblasting and polishing). (See figure 3)

3) Insert the blasting handpiece into the blasting handpiece base. (See figure 4)

4) Sand consumption control: Rotate the sand control knob to control the sand consumption.

5) Water consumption control: Slide water volume control slider to adjust and select the appropriate water volume.

6) Stepping on the foot pedal to start surface polishing treatment. 45° ~60° in jet angle and 4-6 mm in separation distance with teeth is recommended for the best treatment.

7) After finishing treatment, touch power control slider, and then sandblasting system will clean the internal gas circuit automatically for 5 seconds.

8) After self-cleaning,unscrew the sandblasting nozzle (nozzle is single-use)and pull out the handpiece for sterilization.



Notices

- **When doing sandblasting and polishing, doctors must wear special goggles, and the rest shall be protected according to hospital requirements.**
- **When the patient is doing sandblasting and polishing, the patient must be protected in accordance with the requirements of the hospital.**

2.4 Wireless Foot Pedal Function

2.4.1 Operation

Put 2 AA batteries into wireless foot pedal, stick the waterproof rubber on the bottom after covering the battery cover. Leave the wireless foot pedal on the flat ground. After installing the ultrasonic scaler, turn on the ultrasonic scaler power, and then the wireless foot pedal is available.

2.4.2 Applicable Scope

Within any distance of 5 meters, the wireless foot pedal could fully operate the Ultrasonic Periodontal Therapy System.

2.5 Automatic Water Supply System with Double Bottles

Operation

- 1) Open the bottle cap, fill up the purified water, and then tighten the cap.
- 2) Clean the bottleneck and the intake of the main unit.
- 3) Insert the bottle to the water supply bottle intake of the main unit.

4) Press "Liquid: L/R" button to switch the left or right bottle. The light on the bottom of bottle will light up.



Notices

- **Make sure the air intake and outlet are not blocked.**
- **Check the waterproof “O-ring” on the bottle cap is not damaged. If the “O-ring” is damaged or falling, please replace it immediately.**
- **Make sure that the water cap is tighten in case of water leakage.**
- **Clean the connector of the water supply bottle before each use.**
- **When change the liquid inside of water supply bottle, please turn the water volume control slider to the maximum and run the device for 30 seconds in order to maintain and clean the current liquid circuit. Then start the treatment.**
- **When the liquid inside the bottle is low, please fill up the liquid to ensure the regular work.**

2.6 Using and Shutting Down The Device

1)Before and after each use, check whether the equipment and its accessories are in good condition. The main accessories of the product must be used after maintenance.

2)At the end of the working day, you must:

- Rinse the circuit and irrigation tank with distilled or demineralized water.
- Use the one-key cleaning function to clean the residual sand powder in the pipeline.
- Disconnect the handpiece.
- Switch the device off.

3 Sterilization and Maintenance

3.1 Sterilization of handpiece

Handpiece sterilization can refer to cleaning and sterilizing instructions. Please read the instructions before sterilization, and operate according to the instructions.



Notices

- **Before sterilization, use compressed air to blow and clean the cleaning liquid remaining on the handpiece.**
- **Be sure to remove the tip from the handpiece during sterilization, and do not sterilize it with other instruments.**
- **During the process of sterilization and operation, please pay your attention to the external damage of the handpiece at any time. DO not apply any protective oil to the handpiece surface.**
- **Serializable components can be sterilized at least 250 times.**
- **It is strictly prohibited to sterilize the handpiece in the following manner:**
 - Put the handpiece in the solution for stewing.
 - Immerse the handpiece with iodine, alcohol, glutaraldehyde and other disinfectants.
 - Put the handpiece in oven or microwave oven for high temperature baking.

3.2 Sterilization of tip

Tip sterilization can refer to cleaning and sterilizing instructions, please read the instructions before sterilization, and operate according to the instructions.

3.3 Sterilization of torque wrench and endodontic wrench

torque wrench and endodontic wrench disinfection can refer to cleaning and sterilizing instructions, please read the instructions before sterilization , and operate according to the instructions

Attentions:

The Company shall not be responsible for any direct or indirect damage to the torque wrench and the

endodontic wrench caused by the improper use mentioned above.

3.4 Cleaning of tip, torque wrench and endodontic wrench

It is available to clean the tip, torque wrench and endodontic wrench by an ultrasonic cleaning machine. Please refer to the cleaning and sterilizing instructions.

3.5 Maintenance of Sandblasting System

- 1) Press power control slider to make product clean gas circuit automatically for 5 seconds after each using.
- 2) If there is residual liquid in the air/water separator, rotate the knob at the bottom of air/water separator to empty the residual liquid before use.
- 3) Unscrew the filter valve every month and clean the filter spool regularly. Before cleaning the filter, disconnect the main air source. As shown in Figure 6.

3.6 Device maintenance

- Do not use the device if it appears to be faulty.
- Do not use an abrasive cleaning agent on the device.

1)Maintenance

The control unit, the handpiece cord and the foot switch must be cleaned and sterilized on a daily basis.

2)The accessories and cords should be regularly checked for faulty insulation.

Replace them if necessary.

3)When used by patients, the parts of the equipment should not be repaired or maintained.

It is important to keep the control unit ventilation vents clean in order to avoid abnormal heating.

Check that there is no humidity in the handpiece connector. If there is, dry it out by wiping, then blowing with the multifunction syringe.

3.7 Troubleshooting and Notices

3.7.1 Troubleshooting

Faulty	Possible cause	Solutions
No response, no indication.	The power plug is in loose contact	Make the plug insert to the socket well.
	The foot pedal is in loose contact (cord foot pedal).	Insert the foot pedal to its socket tightly.
	The fuse in the main unit is broken.	Change the new fuse.
	The battery for wireless foot pedal died .	Change the new batteries.
No ultrasonic oscillation	The foot pedal is out of order.	Press the reset button(See figure 6).
	The tip is in loose contact.	Screw the tip on the handpiece tightly.
	The connect plug between the handpiece and the circuit board is in loose contact.	Contact the dealer or us.
	Handpiece problem.	Send the handpiece to dealer or us to repair.
	Cable problem.	Contact the dealer or us.

The scaling tip vibrates but there is no spray.	Water volume is too small	Increase the water volume by adjusting the slider
	Insufficient power.	Adjust the power range to the appropriate grade.
Water leak from the product.	The internal pipe is broken down.	Contact the dealer.
The vibration of the tip becomes weak.	The tip has not been screwed on to the handpiece tightly .	Screw the tip tightly.
	The tip is loose because of shaking.	Screw the tip tightly.
	The coupling between the hand -- piece and the cable is not dry.	Dry it by the hot air.
	The tip is damaged. [note 1]	Change the new tip.
Water leak between the handpiece cord and the handpiece.	The waterproof “O-ring” is damaged.	Change the new waterproof “O-ring” .
The endodontic tip does not vibrate.	The screw is loose.	Tighten it.
	The endodontic file is damaged.	Change the new endodontic tip.

No powder, air or water.	No air or water.	Contact the dealer or us.
	Handpiece or nozzle is blocked.	Check if there is air or powder in handpiece cord when pulling out the handpiece. 1) If there is nothing, clean the strainer valve core. 2) If there is air or powder, unscrew nozzle by wrench and clean it by ultrasonic cleaner after clearing the powder.
No powder and water but air.	No powder.	Add some powder to the sand cylinder.
	No water.	Check if there is water in the bottle.
	Humid powder.	Clear and dry sand cylinder and fill it with new powder.



Notice :

If the problem still cannot be solved, please contact with local dealer or us.

3.5.2 Notices

[note 1]

If the scaling tip has been screwed on tightly and there is spray too, the following phenomenon show that the scaling tip is damaged:

- 1) The vibration of tip and the spray from the tip are apparently weakening.
- 2) The noise or droning sound from tip when operation.

4. Contraindication

- The hemophilia disease patient is not allowed to use this product.
- Patients with titanium implants and porcelain restorations should be cautious when cleaning these teeth.

- The patients or doctors with heart pacemaker are forbidden to use this product.
- The heart disease patient, pregnant woman and children should be cautions to use this product.

5. Storage and Maintenance

- The product should be handled carefully and lightly. Be sure that it is far from the vibration, and installed or kept in a cool, dry and ventilated place.
- Do not store the product together with the articles that are combustible, poisonous, caustic and explosive.,
- This product should be stored in a room where the relative humidity is less than 80%, atmospheric pressure is 50 kPa to 106 kPa, and the temperature is -20 °C to +50°C.
- If not use for a long time, please make the machine get through to the power and water once per month. Press mode selection button to clean gas circuit automatically and unscrew the strainer valve to clean the strainer valve core regularly.

6. Transportation

- Excessive impact and shake should be prevented in transportation. Lay it carefully and lightly and do not invert it.
- Do not put it together with dangerous goods during transportation. .
- Avoid solarization and getting wet in rain or snow during transportation.

7.Product List

No.	Name	Remarks
1	Product host	Repairable
2	Handpiece	Accessories
3	Sandblasting handpiece	Accessories
4	Tips	
5	Torque wrench	

























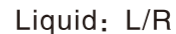









No.	Name	Remarks
6	Endodontic wrench	Accessories
7	Endodontic tip	Accessories
8	Water volume control slider	
9	Connector of liquid circuit	
10	Sterilization box	
11	Power line	
12	Water Supply Bottle(s)	Removable
13	Wireless foot pedal	Repairable/Removable
14	Wired foot pedal	Repairable/Removable
15	Main software	sine_wave_STM32codeV1.000

Note: This instruction manual did not detail the specification parts of ultrasonic scaler; please check the promotion documents and "product list" along with the packing.

8. After Service

According to the warranty card, we offer the life time repair since the product is purchased. The repair of the device should be carried out by our professional technician, We are not responsible for any irretrievable damage caused by the non-professional person.

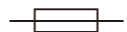
9. Symbol Instruction

	Manufacturer's logo		Caution! read the operation instruction		Class II		Applied part, type B
	Disposal		Manufacturer		Consult the accompanying documents		Serial number
	Autoclavable		Atmospheric pressure for working/storage		Fragile		Storage Humidity
	Storage Temp		Up		Liquid: L/R		Water bottle switch
	Electrical Outlet		Foot pedal connection		Gas 0.5Mpa-0.6Mpa		Adjust liquid
	Minimum power		Maximum power		Disconnect (power)		On (power)
	Production Date		Valid period		Mode		Power indicator
	IP Protection level		CE marking: refers to directive 93/42 EEC.		Stacking layer limit		No rolling
	Fuse		5AA battery		Authorised representative in the European community		

10. Environmental Protection

No harmful factor in this product, and deal with it based on the local regulation.

11. Manufacturer's Right

We reserve the rights to revise the design, technique, fittings, content of the instruction manual and original packing list at any time without notice. If there are some differences between blueprint and real product, take the real device as the norm.

12. Electromagnetic Compatibility

Notice:

- 1) Non-authorized repairs may result in some problems of this product or other products without express consent of Veirun Medical Technology Co.,Ltd.
- 2) VRN-Q6 Ultrasonic Periodontal Therapy System is designed and tested according to the note "Electro--magnetic compatibility".
- 3) Notes: EFT/BEndo indicator light and perio indicator light would be blinking under EFT/B, which will not affect the normal use of the machine and can recover when test finished. According to experienced clinicians, professionally trained how to use specialized equipment and system, this level of risk is accepted.

12.1 Requirements of Cable Installation

Cable Name	Cable Type	Cable Length
Power supply line	Unshielded parallel line	1.2 meter
Foot pedal line	Unshielded parallel line	2.2 meter
Handpiece line	Unshielded parallel line	2 meter

12.2 Critical Components for EMC

Critical components for EMC of this product includes transformer, power line, IC chip. Using or replacing accessories which are not designed or supplied by our company would result in decreased electromagnetic emission and electromagnetic immunity of this product. Do not replace parts of the product without authorization.

12.3 Guidance and Manufacturer's Declaration--Electromagnetic Emissions

Guidance and manufacturer's declaration--electromagnetic emissions		
The models VRN-Q6 Ultrasonic Periodontal Therapy System are intended for use in the electro --magnetic environment specified below. The customer or the user of the VRN-Q6 Ultrasonic Perio --dental Therapy System should assure that it is used in such an environment.		
Emissions test	Compliance	Electromagnetic emissions-guidance
RF emissions GB 4824	Group 1	The models VRN-Q6 Ultrasonic Periodontal Therapy System use RF energy only for its internal function. Therefore, its RF emissions are very low and are not likely to cause any interference in nearby electronic equipment.
Conducted emissions GB 4824	Class B	The models VRN-Q6 Ultrasonic Periodontal Therapy System are suitable for used in domestic establishment directly connected to a low voltage power supply network which supplies buildings used for domestic purposes.
Harmonic emissions GB 17625.1	Noncomplying	
Voltage fluctuations /flicker emissions GB17/25.2	Complies	

12.4 Guidance and Manufacturer's Declaration--Electromagnetic Immunity

Guidance and manufacturer's declaration--electromagnetic immunity			
The models VRN-Q6 Ultrasonic Periodontal Therapy System are intended for use in the electromagnetic environment specified below. The customer or the user of the VRN-Q6 Ultrasonic Periodontal Therapy System should assure that it is used in such an environment.			
Immunity test	IEC 60601 test level	Compliance level	Electromagnetic emissions-guidance
Electrostatic discharge(ESD) GB/T 17626.2	±6 kV contact ±8 kV air	±6 kV contact ±8 kV air	Floors should be wood, concrete or ceramic tile. If floors are covers with synthetic material, the relative humidity should be at least 30%.
Electrical fast transient/burst GB/T 7626.4	±2kV for power supply lines ±1kV for input/output lines	±2 kV for power supply lines ±1 kV for interconnecting cable	Main power quality should be that of a typical commercial or hospital environment.
Surge GB/T 17626.5	±1kV line to line ±2kV line to earth	±1kV line to line	Main power quality should be that of a typical commercial or hospital environment.

Voltage dips, short interruptions and voltage variations on power supply input lines GB/T 17626.11	<5%UT(>95% dip in UT) for 0.5 cycle 40%UT(60% dip in UT) for 5 cycles 70%UT(30% dip in UT) for 25 cycles <5% UT(>95% dip in UT) for 5 cycle	<5%UT(>95% dip in UT) for 0.5 cycle 40%UT(60% dip in UT) for 5 cycles 70%UT(30% dip in UT) for 25 cycles <5% UT(>95% dip in UT) for 5 cycle	Main power quality should be that of a typical commercial or hospital environment. If the user of the models VRN-Q6 Ultrasonic Periodontal Therapy System require continued operation during power mains interruptions, it is recommended that the the models VRN-Q6 Ultrasonic Periodontal Therapy System be powered from an uninterruptible power supply or a battery.
Power frequency (50/60 Hz) magnetic field GB/T 17626.8	3 A/m	3 A/m	Power frequency magnetic fields should be at levels characteristics of a typical location in atypical commercial or hospital environment.
Note: UT is the a.c mains voltage prior to application of the test level.			

12.5 Guidance and Manufacturer's Declaration--Electromagnetic Immunity

Guidance and manufacturer's declaration--electromagnetic immunity			
The models VRN-Q6 Ultrasonic Periodontal Therapy System are intended for use in the electro ---magnetic environment specified below. The customer or the user of the VRN-Q6 Ultrasonic Periodontal Therapy System should assure that it is used in such an environment.			
Immunity test	IEC 60601 test level	Compliance level	Electromagnetic emissions-guidance
Conducted RF GB/T 17626.6 Radiated RF GB/T 17626.3	3 Vrms 150kHz~80 MHz 3 V/m 80MHz~2.5 GHz	3 Vrms 3 V/m	Portable and mobile RF communications equip -- ment should be used no closer to any part of the models VRN-Q6 Ultrasonic Periodontal Therapy System, including cables, than the recommended separation distance calculated from the equation applicable to the frequency of the transmitter. Recommended separation distance: $d = \left[\frac{3.5}{V_1} \right] \sqrt{P}$ $d = \left[\frac{3.5}{E_1} \right] \sqrt{P}$ 800 MHz~800 MHz $d = \left[\frac{7}{E_1} \right] \sqrt{P}$ 800 MHz~2.5 GHz. where P is the maximum output power rating of the

			<p>transmitter in watts(W) according to the transmitter manufacturer and d is the recommended separation distance in meters(m).</p> <p>Field strengths from fixed RF transmitters, as determined by an electromagnetic site survey^a, should be less than the compliance level in each frequency range^b.</p> <p>Interference may occur in the vicinity of equipment marked with the following symbol:</p> 
<p>Note 1:At 80 MHz and 800 MHz, the higher frequency range applies.</p> <p>Note 2:These guidelines may not apply in all situations. Electromagnetic propagation is affected by absorption and reflection from structures, objects and people.</p>			
<p>^a Field strengths from fixed transmitters, such as base stations for radio(cellular/cordless) telephones and land mobile radios, amateur radio, AM and FM radio broadcast and TV broadcast cannot be predicted. To assess the electromagnetic environment due to fixed RF transmitters, an electromagnetic site survey should be considered.If the measured field strength in the location in which the models VRN-Q6 Ultrasonic Periodontal Therapy System are used exceeds the applicable RF compliance level above, the model VRN-Q6 Ultrasonic Periodontal Therapy System should be observed to verify normal operation. If abnormal performance is observed, additional measures may be necessary, such as reorienting or relocating the models VRN-Q6 Ultrasonic Periodontal Therapy System.</p> <p>^bOver the frequency range 150 KHz to 80 MHz, field strengths should be less than 3V/m.</p>			

12.6 Recommended Separation Distances between portable and Mobile RF Communications Equipment and the Models VRN-Q6 Ultrasonic Periodontal Therapy System

<p>Recommended separation distances between portable and mobile RF communications equipment and the models VRN-Q6 Ultrasonic Periodontal Therapy System.</p>			
<p>The models VRN-Q6 Ultrasonic Periodontal Therapy System are intended for use in electromagnetic environment in which radiated RF disturbances is controlled. The customer or the user of the models VRN-Q6 Ultrasonic Periodontal Therapy System can prevent electromagnetic interference by maintaining a minimum distance between portable and mobile RF communications equipment (transmitters) and the models VRN-Q6 Ultrasonic Periodontal Therapy System are recommended below, according to the maximum output power of the communications equipment.</p>			
Rated maximum output power of transmitter/W	Separation distance according to frequency of transmitter/m		
	150 kHz~80 MHz $d = \left[\frac{3.5}{V_1} \right] \sqrt{P}$	80 MHz~800 MHz $d = \left[\frac{3.5}{E_1} \right] \sqrt{P}$	800 MHz~2.5 GHz $d = \left[\frac{7}{E_1} \right] \sqrt{P}$
0.01	0.12	0.12	0.23
0.1	0.38	0.38	0.73
1	1.2	1.2	2.3
10	3.8	3.8	7.3
100	12	12	23

For transmitter rated at a maximum output power not listed above, the recommended separation distance d in meters(m) can be estimated using the equation applicable to the frequency of the transmitter, where P is the maximum output power rating of the transmitter in watts(W) accordable to the transmitter manufacturer.

Note1: At 80 MHz and 800 MHz, the higher frequency range applies.

Note2: These guidelines may not apply in all situations. Electromagnetic propagation is affected by absorption and reflection from structures, objects and people.

VRN-Q6 Ultrasonic Periodontal Therapy System has been tested and homologated in accordance with IEC 60601-1-2:2014 for EMC. But it is no guarantee in any way that this device will not be effected by electromagnetic interference. Avoid using the product in high electromagnetic environment.

13.Attached table: Power Table of Tip

Scaling		
Model	Gear	Water amount
G1	1-10(G)	Yes
G3	1-10(G)	Yes
G4	1-6(G)	Yes

Periodontal			P12R	1-6(P)	Yes
Model	Gear	Water amount	P16	1-6(P)	Yes
P1	1-10(P)	Yes	IM1	1-4(P)	Yes
P11	1-6(P)	Yes			
P12	1-6(P)	Yes			
P12L	1-6(P)	Yes			

Root canal		
Model	Gear	Water amount
E1	1-3(E)	Yes

Electrical schematic diagram

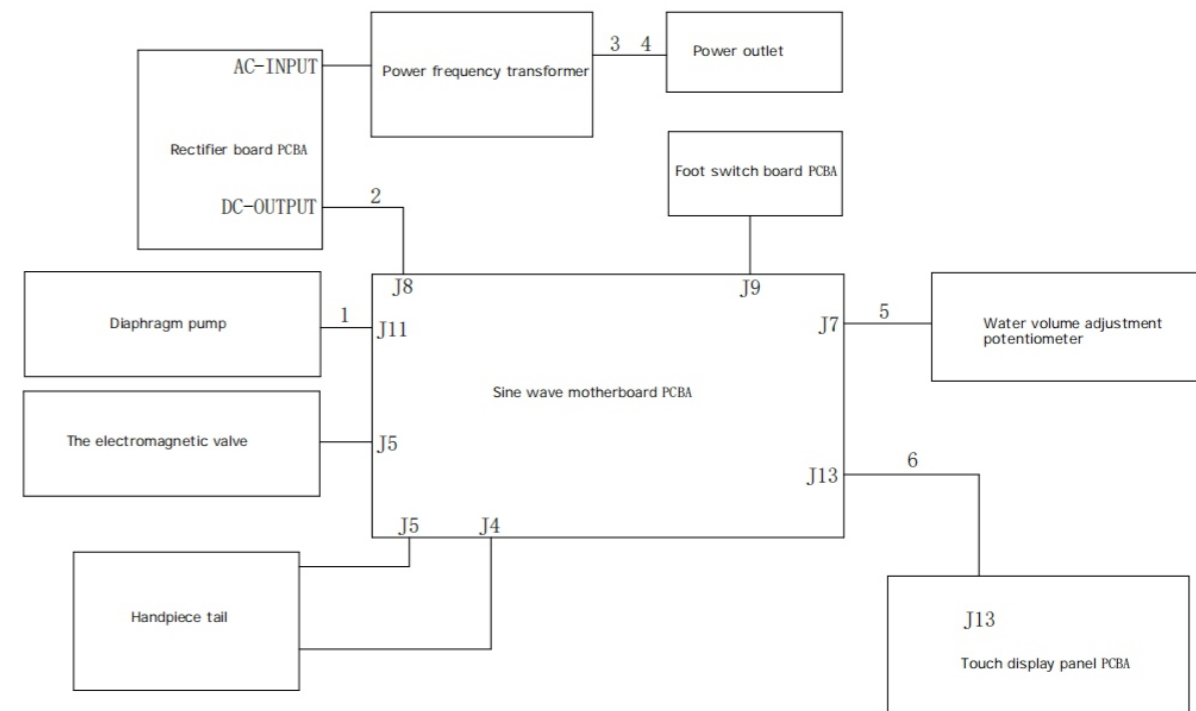

The control signal is given to the main control board through wired or 2.4GHz wireless communication. The main control board of the product can control the water pump, solenoid valve and handle work.