

A wise choice!

Thank you for making the decision to purchase T series controlled dental chair unit, a modern, safe and easy-to-use dental unit for you!

Index

1、 Components.....	1
2、 Technology Parameter.....	1
3、 Transports and Stores.....	1
4、 Normal Work Movement.....	1
5、 Machine Structure.....	2
6、 Diagrammatize.....	3
7、 Equipment installation.....	4
1、 Install preparation.....	4
2、 Installation steps.....	4
8、 Debugging&Use.....	7
1、 Air turbine H.P.....	7
2、 Three way syringe.....	7
3、 Weak suction and strong suction apparatus.....	7
4、 Lamp.....	8
5、 Arm rest.....	8
6、 Multifunction foot controls switch.....	8
7、 Control panel.....	8
9、 Maintenance.....	10
1、 Handset clean maintenance.....	10
2、 Water filter.....	10
3、 Filter pressure reducing valve.....	10
4、 Weak suction and strong suction apparatus.....	11
5、 Dental chair.....	11
10、 Clean and disinfection.....	11
1、 H.P. disinfection.....	11
2、 Disinfection of the suction pipeline.....	11
3、 Disinfection of the spittoon.....	11
4、 Disinfection of the three way syringe.....	11
11、 Spare parts replacement.....	12
1、 Protector tube replacement.....	12
2、 Lamp bulb replacement.....	12
12、 Matters needing attention.....	12
13、 Trouble shooting.....	13
14、 Electricity principle diagram.....	14
15、 Water and air principle diagram.....	15

Components

- Main unit
- Doctor stool
- Lamp
- Lamp arm
- Water&air pipe
- Tap water connector
- Screw for adjustment
- User guide

Technology Parameter

Power supply: AC 220V 50HZ/110V 60HZ

Input air pressure:0.5MPa ~ 0.8MPa

Input air Flow: ≥ 50 L/min

Input water pressure: 0.2MPa ~ 0.4MPa

Input power: 800W

Fuse specification: 5A, $\Phi 5 \times 20$ mm

High speed H.P. working pressure: 0.25MPa

Low speed H.P. working pressure: 0.35MPa

Transports and Stores

This machine should transport and stores up under following condition

Ambient temperature range: $-40^{\circ}\text{C} \sim +55^{\circ}\text{C}$

Relative humidity range: $\leq 93\%$

Atmospheric pressure range: 500 hPa~1060 hPa

Normal Work Movement

Be to ensure that this machine regularity works , this the machine power supply and the environment technology demand as follows:

Power supply: Single phase 220V ± 12 V 50 Hz ± 1 Hz

Gas source: Pressure ≥ 550 kPa Rate of flow ≥ 50 L/min

Source of water: Water pressure 200~400 kPa

Ambient temperature range: $+ 5^{\circ}\text{C} \sim +40^{\circ}\text{C}$

Relative humidity range: $\leq 80\%$

Atmospheric pressure range: 860 hPa~1060 hPa

Machine Structure

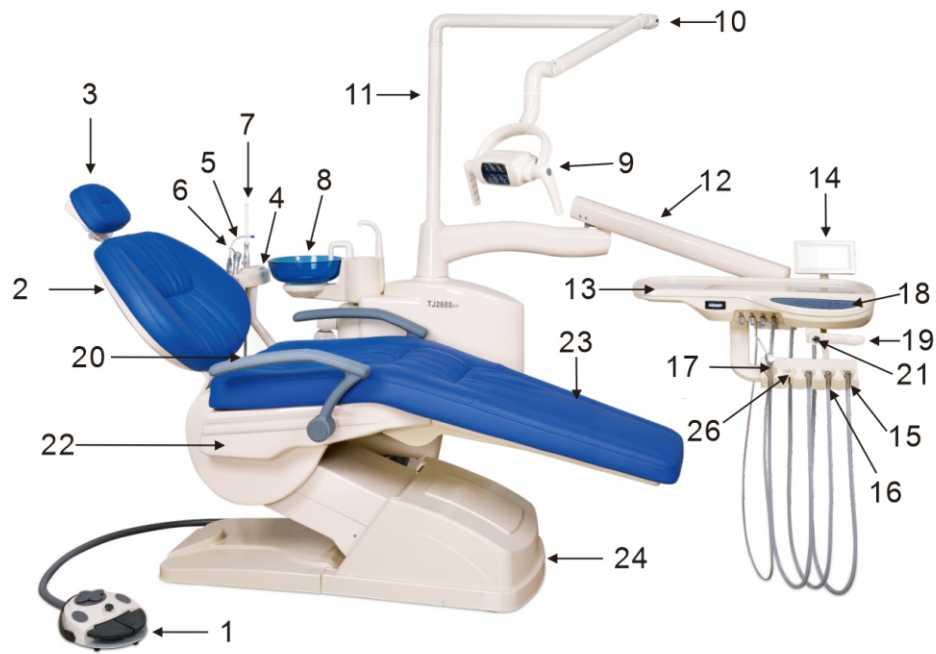

Figure 1 the structure of the controlled integral dental unit

- | | |
|----------------------------|--------------------------------|
| 1、Chair back | 11、Arm |
| 2、Head pillow | 12、Instrument tray |
| 3、Assistant control tray | 13、X-film viewer |
| 4、Weak suction apparatus | 14、High speed air turbine H.P. |
| 5、Three way syringe | 15、Low speed air motor H.P. |
| 6、Strong suction apparatus | 16、Three way syringe |
| 7、Spittoon | 17、control panel |
| 8、Lamp | 18、Shake hands |
| 9、Lamp arm | 19、Armrest |
| 10、Lamp arm column | 20、Base cover |
| | 21、Bottom cover |

Control Signs



B type equipment



Ascending button



Bending button



Rinse the spittoon key



lamp switch



Step switch



Remember key 2



Sputum place key



Descending button



Lifting button



Mouth wash key



Water heater switch



Remember key 1



Remember key 3



Reset button

Equipment installation

1. Install preparation

When choosing appropriate location for installation, the general layout of the clinic, ventilation condition, illumination and convenience are all crucial factors to be taken into consideration. The equipment should be installed in clean, dry place featuring good ventilation and convenience in operation. The ground in direct contact with the dental chair should be flat, smooth and solid. (see the figure 2)

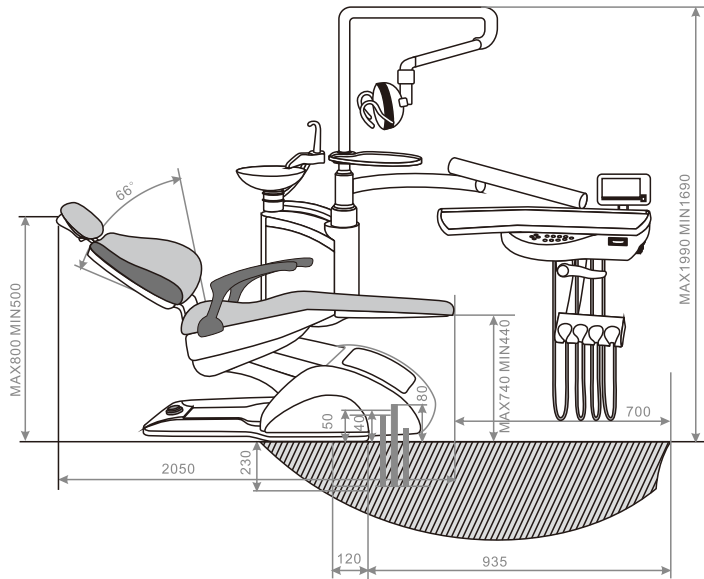

Figure 2 Equipment assembles the space dimension

The conducting wire cross section providing this machine responds to $> 1\text{mm}^2$, and ensure that this machine is fine ground connection.

2. Installation steps

(1) Open the box and have a check

Take off the cover of the unit, check the machine is being excellent without damage. And check the accessories are in good condition and according to the packing list. Then take off the Cartons of Doctor stool, Lamp and Lamp arm. Remove the screws which fixed the wooden box and machines.

(2) Dental chair installation

Put the dental chair on the right position that you have chosen before. Our designs have been considering that the stability quality about the machine, so it's unnecessary to fix the unit by screw. The ground in direct contact with the dental chair should be flat, smooth and solid, avoid some accident by the rough ground.

If the ground contacted by chair is not smooth, the six attached M12×6 socket hexagon screw may be fixed in the six holes of chair for full contact with ground. (See the figure 3) make sure the base plate has maximum contact area with ground for best stability of machine.

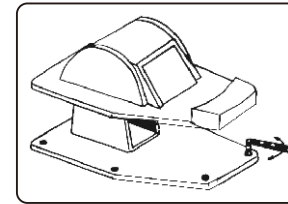
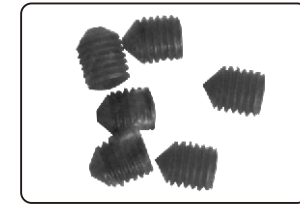

Figure 3 Fix the dental chair



M12×6 socket hexagon screw

(3) head pillow installation

Take the pillow out from the Doctor stool Carton. Insert it into the pillow support on the chair back. Pillows can be adjust to different position and suitable for adult or children.

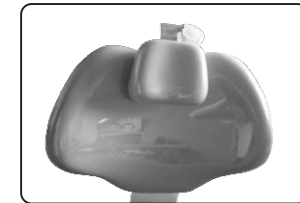
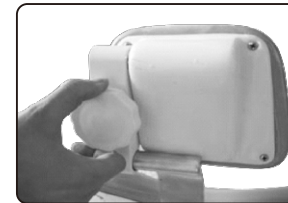

(4) lamp installation

Put the wire from the lamp arm through the lamp stand and connect the stand to the arm. Then connect the wire connector on the new lamp arm to that in the main dental unit and place onto the column/main dental unit. Ensure the wires are not damaged in this process.

Lamp Stand



Lamp Arm

Place the decorative sleeve over the lamp arm before connecting the wire connectors between the lamp arm and the lamp handle/unit. Then connect the lamp handle/unit to the lamp arm with the supplied screw. Finally slide the decorative sleeve back down and over the lamp handle/unit.

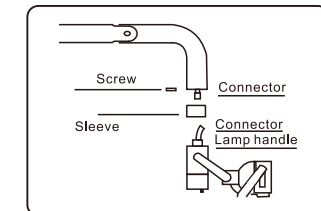
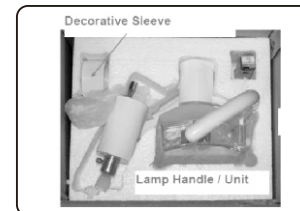

(5) Dental stool installation

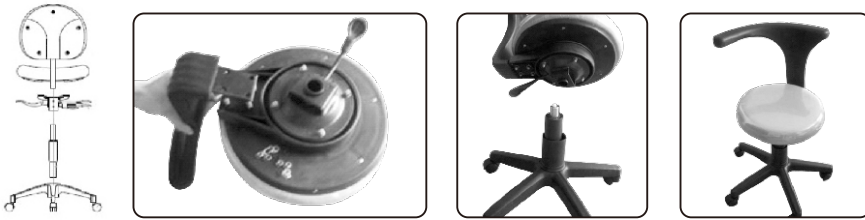

(6) Water and air source connecting

We provide two more than 3m 8×5 pipe for connecting the water and air. You can follow your water and air source position choose the length of the pipe. Take away the base cover of the unit and use the attached 8×5 pipes to connect water and air source.

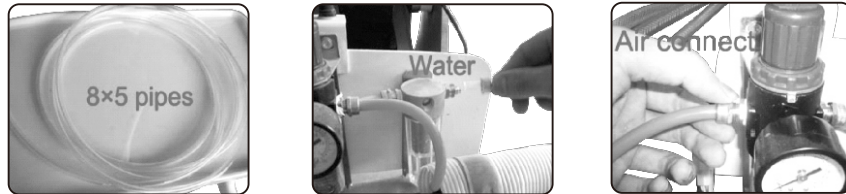

(7) Drain pipe connecting (three 1/2" (inch) pipes together in a 1/4" (inch) White corrugated tube)

- If there is a house drain on the ground of the chair position, you can direct connect the drain pipe of the unit to your house drain on the ground.
- If the house drain system is away from the chair, please let the drain pipe of the unit out from the front of the base cover. (If the pipe is not long enough, please connect another tube of your own)
- If you need connect a suction pump machine, please use a 3-to-one pipe-adaptor connect the three pipes and connecting to your suction pump machine.

Note: Do it securely and guarantee smooth drainage.



(8) Handpieces(H.P.) installation

According to the H.P. specifications, connected the H.P. well. And pay attention to not to use it in condition of overpressure or when the needle is not fixed.

Debugging & Use

1、 Air turbine H.P.

Turn on the power, the air supply and the water supply to get the unit to be in the state of readiness. Check the air pressure gauge at the air filter reducing valve under the base cover. It should read 0.5MPA. If the air pressure is too low or too high, adjust the air reducing valve until it reads 0.5MPA.(Instructions: Take out the base cover, pull up the knob on the top of the air reducing valve and rotate the knob to 5MM, clockwise to increase the pressure, counterclockwise to reduce the pressure.)



Figure 4 Air filter reducing valve

Take off the air turbine H.P. from the rack and press the foot switch. The machine will run right now. (Caution: the pressure from the pressure gauge of instrument tray is the working pressure by air turbine H.P. It's no permission to over the highest rated voltage. If it's necessary to adjust the pressure, you can use the air-adjusting valve under instrument tray. (See the figure 5) Also, use the water-adjusting valve of instrument tray to change the volume of the H.P. (see the figure 6)

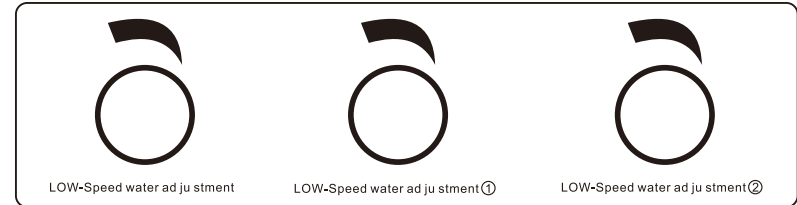

Figure 5 Air adjusts for H.P.

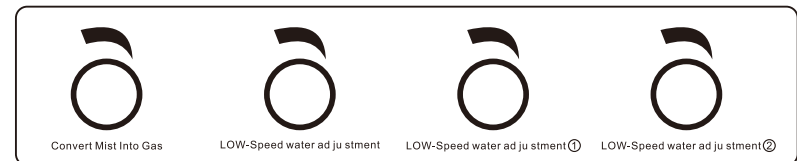

Figure 6 Water adjusts for H.P.

2、 Three way syringe

Press the relevant button to spray water (air), check it if similar to the figure you have seen on the button.

3、 Weak suction and strong suction apparatus

There is weak suction and strong suction apparatus of the machine. Pull out the suction apparatus from the rack, it will turn on automatically; place it back to the rack, it will turn off automatically.

(Caution: be sure not to place them back in different rack)

4、lamp

Turn the switch of lamp left and right to shift between the strong light and weak light. If the switch is in the middle position, the lamp is turned off. The lamp can regulate various irradiation positions arbitrarily to adapt the demand of treatment work. The lamp uses the 12V/55W electric bulb as illumination source and with the speculum by heatless light membrane. The most suitable irradiation distance is about 70CM to the operation lamp. The light spot presents a long form, and shining on strong and weak two ways.

5、 Arm rest

The arm rest on the left side is fixed, it can not move.

The arm rest on the right side is can be lift or down. (There are two models, see the Figures of below)



Model A: Push the arm it will be down. Model B: Lift a little and turn left

6、 Multifunction foot controls switch



Figure 8 Foot control switch

(1) The dental chair's step switch

Press the start switch on the top of the step switch, press to the (UP) direction, the chair will ascend; press to the (DN) direction, the chair will descend; press to the (BU) direction, the chair back lifts; press to the (BD) direction, the chair back will bend forward.

(2) The H.P. step switch

Step on the pedal of the step switch, pressing it, the H.P. will work, release it to stop. Step on the pedal and put the water control switch to the right direction, H.P. will work with water; Step on the pedal and put the water control switch to the left direction, H.P. will work only.

7、 control panel (See page 5 Control signs)

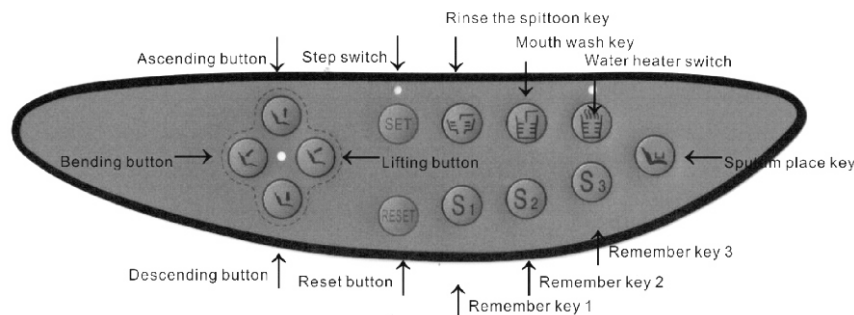

(1) Power indicating lamp

Puts through the power supply, turns on the power switch, the indicating lamp is on.

(2) Ascending button

Press this button, the chair will ascend, while the dental chair rises to required position, then release the button to stop.

(3) Descending button

Press this button, the chair will descend, while the dental chair down to required position, then release the button to stop.

(4) Lifting button

Press this button, the chair back will lift up and inclines backwards, while the dental chair lift up to required position, then release the button to stop.

(5) Bending button

Press this button, the chair back will bend forward, while the dental chair bends forward to required position, then release the button to stop.

(6) Step switch

Press the step switch, indicator light is on, and then you can get into setting condition, setup the chair position remember, mouth wash water etc..

(7) setup indicator lights

Press the button, the light is on, after you finished, the light is off.

(8) Rinse the spittoon key

Press the button, the water will run out, press it again to stop.

(9) Mouth wash key

Setting method:

① Press the set button, the light is on.

② Pressing the button, the water will run out by the system.

③ When you think that the water is enough, release the button to finish, the light is off.

④ Caution: if you want to change the setting by water supply, you can change it by the steps we had given you before.

(10) Water heater switch

Press the button, indicator light is shining, the water heater is working, when the water temperature is raised to the setting temperature, indicator light is on, and the heater will stop working; when the temperature is down, the heater will work by itself. Press the button again, the heater stop, and the indicator light off. (Caution: Don't press this button when its no water.)

(11) Indicator light of the heater

When the heater is working, the light is shining; when the temperature did not change, the light is on: and when you turn the heater, the light is off too.

(12) Spread button

Press this button, the chair back will move backwards to the lowest position with the cushion rising to the highest position.

(13) Reset button

Press this button, the chair back will move to the highest position and the chair will down to the lowest position, when the chair is working, you can press the step switch to stop.

Maintenance

1、 H.P.

Please refer to the instruction for the maintenance of H.P.

2、 Water filter cleaning

Be sure to use the unit in normal condition, we have design the water filter to stop impurity into the machine. But the water is not through because of the dirty, so, you must wash the filter core or change it.

In usual condition, if there is something wrong by the following question, then you must wash the filter core or change it.

- (1) Use the machine more than one year.
- (2) The filter core loses pressure above 0.1 MPA.
- (3) The filter core is contaminated.
- (4) The muddy water is running out .

Carry out the following method to wash the filter or change it:

- (1) Cut off the power supply and close the water valve switch.
- (2) Open the front cover of the dental chair and take the water filter down with the spanner.
- (3) Move the covering to left-hand direction, and take the filter core down in the middle of the water filter ,then you can wash it or change it.
- (4) After that, you can fix it with the steps from steps three to steps one.

Caution: you must be carefully by fixing the filter core, and make the cover airproof.

The specification of the filter core is: Outside diameter: 23 mm inside diameters: 20 mm length: 33 mm density: 30 mums

3、 Filter reducing valve

To ensure steady, clean and dry air input in daily use, the instrument is equipped with an air filter decompressing valve installed at the air entrance at the front cover.

This valve keeps air pressure in a preset value and filters away dust and moisture content. The moisture contents blocked will gathers in the filter glass. After a certain period of time, the gathered water must be drained away to avoid influencing filtereffect.

Generally, water must be drained from air filter decompressing valve if one of the following occurs:

- (1) Instrument has been used for more than one week.
- (2) Water in filter glass occupies 3/4 volume of the glass.
- (3) There is a color change in the water in the filter glass

Methods of water drainage from filter reducing valve: open the front cover of the dental, touch the filter core on the bottom of the filter by your hands or something hard, go upward and the water will run out ,remove your hand when the water is running out. In order to keep the environs clean, the water exit may be matted with water absorption materials like cloth, tissues and sponge, etc to absorb drained water.

Methods of water drainage from filter reducing valve:

- (1) Shut down the power and air source.
- (2) Open the front cover, move the red nut on top of the valve to take down the air filter valve.
- (3) Take down the filter core , and wash it by neutral cleaning liquid.

Caution: you must be carefully by fixing the filter core, and make the cover airproof.

The specification of the filter core is: Outside diameter: 14 mm; inside diameters: 16mm; length: 23 mm; density: 40 mms

4、 Weak suction and strong suction apparatus

There are weak suction and strong suction apparatus with the dental chair, the strong suction apparatus is suck by air, because it take too much air ,so please put it back to the rack when you finished. We should keep the weak suction and strong suction apparatus clean not only for the surface but also for the inner pipeline system. It's necessary to suck the water and clean it by special disinfection of water in 30 minutes regularly. Last ,suck a glass of water when you finish using the apparatus each time, in order not to block the pipeline.

5、 Dental chair

It's necessary to maintain the chair regularly, in order to keep the chair wear well and beauty always.

- (1) The chair will be ageing by touching with oil and the other corrosive, it should be avoided. The pillow can be taken down to disinfected with medical alcohol also.
- (2) The surface can be cleaned and disinfected with medical alcohol to keep it beauty, at the same time, not to touch it by sharp or something hard.
- (3) When you didn't use the chair, please down the chair to the lowest position and up about 5cm. Stay the chair in dry environment that you can use it for a long time.

Clean and disinfection

1.H.P. disinfection

Please refer to the instruction for the disinfection of H.P.

2. Disinfection of the suction pipeline

Sterilize the suction pipeline in the high-pressure, high-temperature, vacuum, and disinfection box, suggested to use the throwaway suction pipeline.

Weak suction tubes interface specification: $\Phi 7\text{mm}$

Strong suction tubes excuse specification: $\Phi 11\text{mm}$

3. Disinfection of the spittoon

Use running water to wash the spittoon first, use alcohol after is OK.

4. Disinfection of the three-way syringe

Press the button of the three way syringe and take down the nozzle, then Sterilize the nozzle in the high-pressure, high-temperature, vacuum, and disinfection box, put it back to the rack when it finish disinfection.

Spare parts replacement

1. Protector tube replacement

Have assembled a fusible cut-out for avoiding causing bad effects on consumer's current supply network because of this machine short circuit malfunction on this machine circuit, the fusible cut-out assembles within dental chair front cover , the step is in progress time replacement according to the following:

- 1) Break previous step equipment power source up (allocate away the power source attachment plug)
- 2) Before opening the dental chair, cover uses hand whorl to come untied being sure that cover takes out the insurance tube already having burned.
- 3) Be in charge of according to marking, putting new corresponding insurance in.
- 4) Handle according to as said or narrated above contrary step.
- 5) Protective tube specification: 5A Φ 5×20mm

2. Lamp bulb replacement



figure 12 lamp

Shut down the power, take away the outer board and the light bulb. Its ok to change a light bulb under dumping.(Pay attention to: When changing a light bulb, should avoid hand and light bulb glass when contacting , being stained with to avoid using a light bulb greasy dirt) again installation being OK according to all above contrary procedure operation.

Matters needing attention

1. When the dental chair in operation, ensure that no obstacles should be in the way when the dental chair ascends and descends.
- 2.The socket and wires should conform to standard requirement. The grounding lines should be firm enough.
- 3.Remove the water in the Air filtration valve and cleaning or replacement the filter-core of the water filtration valve timely.
- 4.Don't the heater when its no water.
- 5.It is prohibited to put things of too heavy on the instrument tray.
- 6.Take care that water supply, air supply, and power supply are turned off on off-duty time or doesn't use for a long time.
- 7.The air pressure of dental unit and the adjustable range of dental chair position have been set in production. Arbitrary adjustment by non-professional is prohibited.
- 8.Read the specifications carefully before using the equipment. All instruction and regulations should be observed seriously in operation.

Trouble shooting

No	Description	Possible reasons	Action
1	The H.P. is weak when it is working	1、 The needles are not good. 2、 The bearings are not good. 3、 The working pressure is too low. 4、 Obstruction inside the nozzle.	1、 Change the needle. 2、 Change the bearing. 3、 Check air pressure. 4、 Check the duct.
2	The working pressure is unstable.	1、 The air filtration valve is blocked. 2、 The air duct is tangled. 3、 The air supply is not turned on fully.	1、 Clean the air filtration valve. 2、 Check the duct.
3	There is no water blowing out from the H.P.	1、 The water pipe of H.P. is blocked. 2、 The triple diaphragm valve is not well adjusted. 3、 The water adjusting valve is not well adjusted.	1、 Refer to the operation manual of the H.P. 2、 Check the triple diaphragm valve. 3、 Adjust the water-adjusting valve.
4	Air leakage in the H.P. when it is not being used.	The rack valve assemble location alteration	Open single switch, adjusting the front and back position of the single switch.
5	Source of water pressure regular, but the machine have no water	The water filtration valve be block	Clean or replace a water filtration valve
6	H.P. has a gas anhydrous	Water pressure is too low	1、 Raise water pressure 2、 Replace the gas valve control
7	The dental chair has unusual noise when action , with in machine	1、 The motor component is damaged or loose 2、 Be obstructed	1、 Renovation the damaged or loose component 2、 Dislodge obstructed object
8	Leakage in the H.P. connection.	The washer of the high-speed H.P. is not good.	The washer should be replaced.
9	There is no water springing out from the spray gun.	The water pipe is blocked	Check the pipes.
10	There is water vapor when spraying with the spray gun.	There is too much water accumulated in the air filter.	The filter should be drained.
11	Mouth wash is not hot	The heater controls circuit malfunction or the heater burns	Replace the control circuit malfunction or change a water heater

Electricity principle diagram

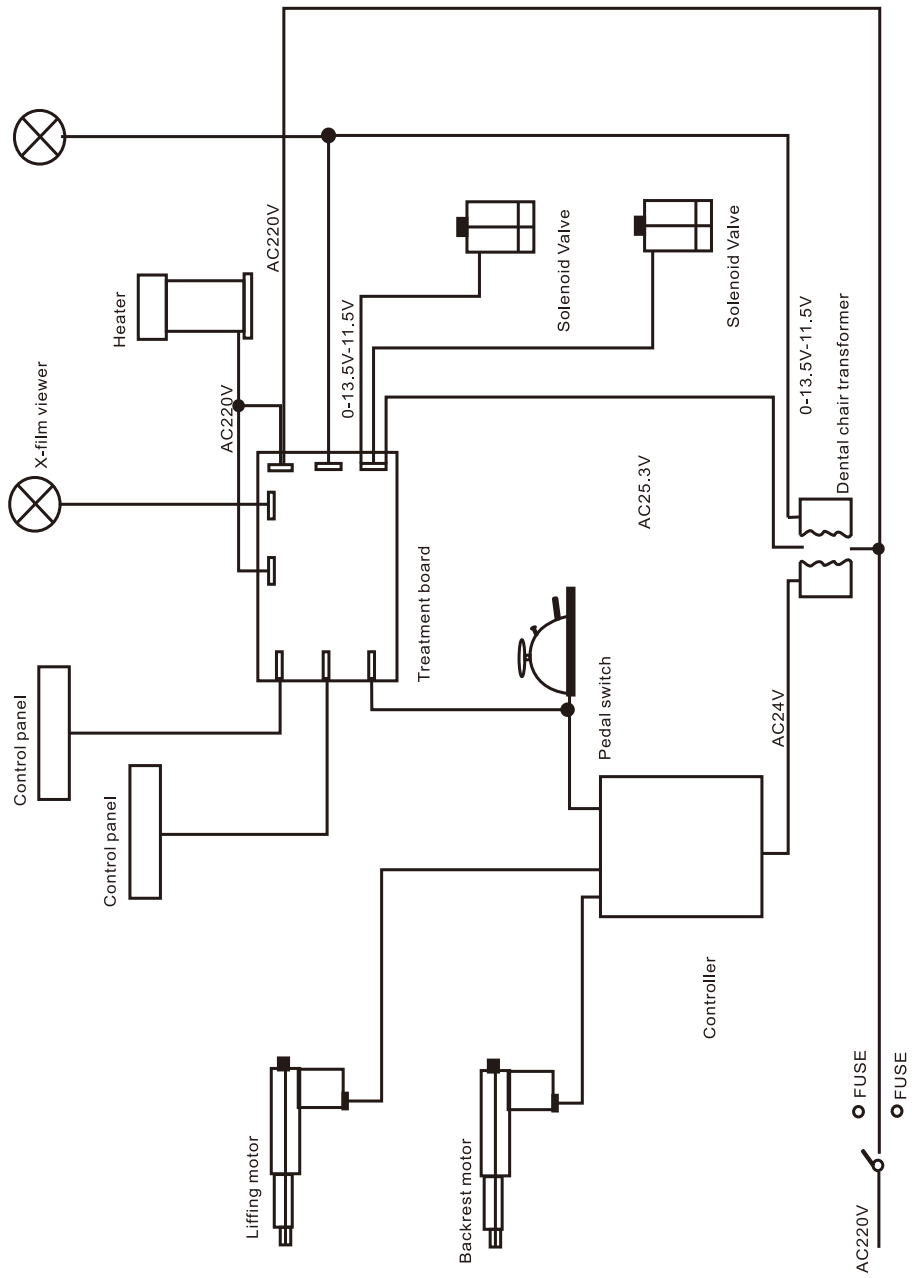

Water and air principle diagram

