

MANUAL

DENTAL SIMULATOR

MODEL: TR-DTS10

INSTRUCTION MANUAL

MENU

目录

●Product introduction	3
●Overall structure	4
●Technical data	4
●Working environment	4
●Transport and storage condition	5
●Installation procedures	5
●Commissioning and operation	8
●Maintenance	10
●Note	10

ATTENTION:

**PLEASE KINDLY READ THIS MANUAL
CAREFULLY BEFORE OPERATION.**

●Product introduction

Thank you for purchasing our MANUAL DENTAL SIMULATOR, Model TR-DTS10. It is practice equipment, which used for dental school, universities and oral medicine specialized student before clinical practice teaching simulation. It has such advantages as solid structure, handsome shape, easy operation and high reliability as an ideal upgraded products for the modern dental clinics. During this simulation environment, the students can know and control clinical operation technology of oral courses as early as possible, also help them to get familiar with clinical teaching environment. It can make the professional theory teaching, experiment teaching and clinical teaching effectively combined well. This also benefit to the students to improve their professional learning enthusiasm and interest, strengthen their theoretical knowledge, cultivate the students' oral medicine clinical thinking ability, improve their operation skills.

DENTAL SIMULATOR (MODEL:TR-DTS10) mainly includes: Movable base, Simulated head model, 3-way Syringe, Air suction, Foot control, LED lamp, Dentist stool, Water storage bottles, Stainless plate(optional).

●Overall structure (Figure 1)



Figure 1

●Technical data

Technical data of simulator

- (1) Power supply: AC 220V, 50Hz
- (2) Input power: 72W

●Working environment

- A: An ambient temperature range of -20 to +40
- B: A relative humidity range is not more than 80%
- C: An atmospheric pressure range of 860 hPa to 1060 hPa.
- D: Barometric source: Atmospheric pressure > 500KPa, Flow>55L/Min, water pressure: 200Kpa to 400Kpa
- E: Drainage pipeline: 1cm leaning to the drainage-way per mater tube.

●Transport and storage condition

- A: An ambient temperature range of -20°C to +40°C.
- B: A relative humidity is not more than 95%.
- C: An atmospheric pressure range of 700 hPa to 1160 hPa.
- D: Non-corrosiveness gas inside.

●Installation procedures

1. Unpacked check

Unpack the packing carton and check if the equipment is sound without any damage. Check if the accessories and spare parts are complete and sound according to the packing list. For any question, please do not hesitate to contact the manufacturer.

2. Manual Dental Simulator Installation

The dental simulator should be installed on even and solid ground and keep the ambient clean, dry, ventilated and cool. Keep away the sunshine.

3. Connection of air compressor

Connect the transparent tube in front of the machine with the air compressor.

Before the connection of pipes, discharge the water and air inside the equipment first, then

remove dirt and impurity inside the pipes to prolong the service life of this equipment.

Remove dirt and impurity inside the pipes and prolong the service life of this equipment first, then remove dirt and impurity inside the pipes to prolong the service life of this equipment.

4. Installation of oral lamp

A. Connect the lamp base wire inserter through the decorative cover to the lamp arm wire inserter (Connector 1 in the arm, figure 2) , insert the lamp base handle into the lamp arm hole, and fasten it with screws and then cover the screw, and seam with the decorative cover. (figure 3 and figure 4)

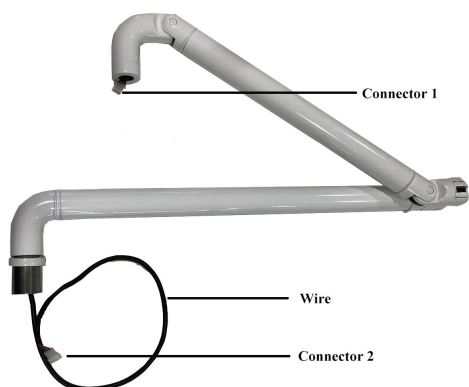

Figure 2



Figure 3

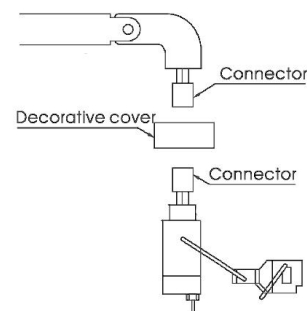

Figure 4

B. Put the black wire through the straight arm.

C. Connect the “Connector 2” (figure 2) with the connector on the movable machine. Like figure 5 shows. ((Note: don’t damage the wire.))



Figure 5

5. Assemble the simulation head model

A. Put the metallic part into the check, from the up side down. See Figure 6, 6, 8 show.

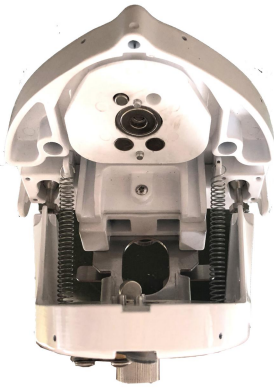
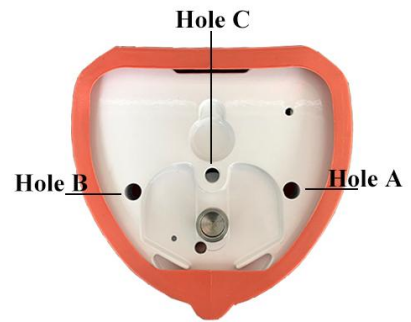

Figure 6



Cheek(front view)

Figure 7



Cheek with metallic part
(vertical view)

Figure 8

B. Match the “Hole B” “Hole A” (figure 8) corresponding to “Metallic part B” “Metallic part A”(figure 9), and “Screw 1” to the “Hole C”(figure 8, 9). Twist the black “Handle” clockwise, then fix. (figure 10)

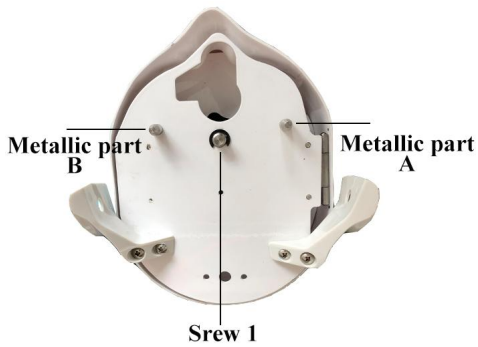

Back side of the simulation head

Figure 9



Handle

Figure 10

C. Fix the simulation head and simulation body with screw. (Check the circles in figure 11, 12).



Figure 11



Handle

Figure 12

D. Adjust the simulation head. Twist the handle to FRONT, then you can adjust the

direction, twist the handle to the BACK (figure 13), settle the simulation head. It's multi-direction.(figure 14)



Figure 13



Figure 14

• Commissioning and operation

1. Saliva ejector

A. Take out the saliva ejector from the holder, it will work.

2. Water storage bottle

A. Clean water storage bottle, the clean water use for handpiece and syringe comes from here.

E. Dirty water storage bottle, the dirty water from the suction will be stored up here.

3. Power Supply Connection

The machine is equipped with the single-phase three-pinned socket in advance. Without the connector, the user cannot switch it on until the electrical outlet is connected to the ground wire.

7. High/ Low speed handpiece

Connect water, air and power supply. Open the general air switch on the side of the movable simulation treatment machine, and check the pressure gauge after open the plastic door . (figure 16) The value should be 0.5~0.6 MPa (factory setting). Adjust the filter relief valve if it is required to maintain the said value. Open the plastic door, pull the handle on the top of the filter relief valve up for about 10mm as shown in (figure 16), turn the

handle clockwise to increase the pressure and anticlockwise to decrease the pressure.

Take the handpiece from the holder, step the pedal switch for operation. Be noted that the pressure indicated on the pressure gauge of the instrument disc is the operating pressure of the handpiece, which should be no more than the rated maximum pressure of the handpiece to protect the handpiece against damage (High speed: 2.0-4.0bar, Low speed: 3.5-4.0bar), see the figure 17. Adjust the operating pressure of handpiece if it is required by regulating the main control valve under the instrument disc. Turn the handle clockwise to increase the pressure and anticlockwise to decrease the pressure. Adjust carefully and slowly.



Figure 16

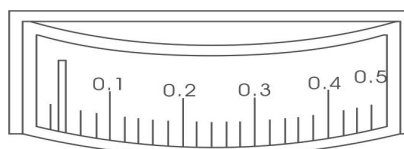

Figure 17

8. Three-way syringe

The left button is for water and the right one is for gas.

See figure 18.

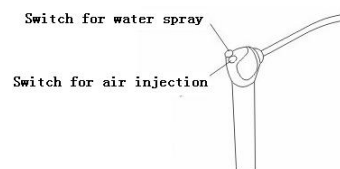

Figure 18

9. Air suction and saliva ejector

Saliva aspirator is provided with this equipment. Take the saliva ejector from the holder to start operation immediately. Water connection is required for low aspiration to guarantee minimum operating pressure required.

10. Clean water storage bottle

Water for handpiece is directly from the water bottle, therefore the bottle shall be supplied with medical distilled water on time, with water filling described as below: Turn off the air switch beside the water bottle firstly. After all the compressed air in the bottle discharged, hold the water bottle securely and turn clockwise to take it off. Then fill water in it, turn it on counter-clockwise, until it fixed on the bottle cup tightly (Air tightness must be

regarded). Finally turn on the air switch.

11. Dirty water storage bottle

The waste water comes out from the simulation mouth through the saliva aspirator, will go into the waste water storage bottle. (On the left side of the machine without blue tube in it.) Hold the water bottle with both hands, rotate clockwise to take off the water bottle, pour out the waste water and rotate anticlockwise to tighten the bottle (sealed).

● **Maintenance**

1. After adjust the simulation head, ensure it is locked before it is used.
2. Regularly cleanse the water filter.
3. Power supply is 220VAC
4. Cut the power supply before repair the wearable component and cleanse, maintain the treatment machine.
5. Should close the lamp, when it is not used.
6. To ensure the neat and tidy of the treatment machine, cleanse the surface of the machine and chair with hospital use alcohol regularly is suggested.

● **Note**

1. The power cord should be configured as standard and the ground wire should be firmly connected.
2. When replacing electronic components, the power must be turned off.
3. Before the maintenance and cleaning of the equipment, the power must be turned off.

Transport and storage environment:

1. Ambient temperature: -40 ~ + 70 °C;
2. Relative humidity: 20% ~ 90%, including condensation;
3. Pressure: 806 ~ 106 hPa.
4. The rain must be prevented during transportation and gently handled to avoid vibration.
5. Treatment of waste water and other materials must comply with local environmental protection regulations.
6. Packaging units should be stored in places where the relative humidity does not exceed 80%, where there is no corrosive gas and air circulation.
7. The maintenance of the equipment must be performed by professional technicians designated by our company. If the user disassembles and repairs the device by himself, the device may be damaged, and if this happens, our maintenance service will no longer be available.