

User Manual of Suction Machine
TR-YP606L

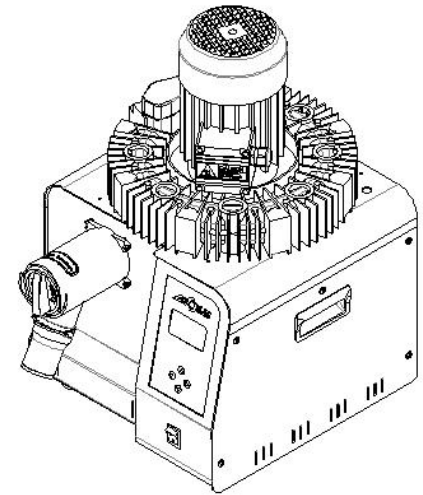

Contents

1. Functional Description.....	2
2. Safety Measures.....	2
2.1 Important safety signs.....	2
2.2 For installation	3
2.3 For power supply.....	4
2.4 For operation.....	5
2.5 For cleanin.....	6
2.6 For environmen.....	7
2.7 EMC.....	7
3. Main Components.....	7
4. Main Product Parameters.....	8
5. Product Installation.....	8
5.1 Unpacking.....	8
5.2 Installation condition.....	9
5.3 Requirements for normal operating environment.....	9
5.4 Pipeline/signal line connection.....	9
5.5 Use after connection.....	10
6. Cleaning and Maintenance.....	10
6.1 External cleaning.....	11
6.2 Filter screen cleaning.....	11
6.3 Pipeline cleaning.....	12
6.4 Fan maintenance.....	12
7. Troubleshooting.....	13
8. After-sales service.....	13
9. Appendix.....	14

9. Appendix

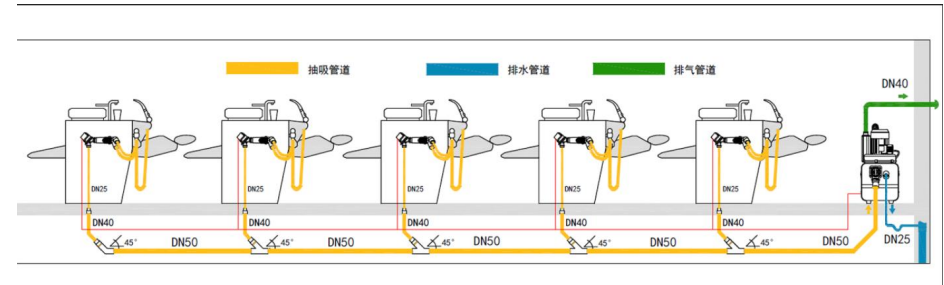

- ① This dental suction's pipeline is only for semi-Dry dental suction, suggest dental unit be to install Place Selection Valve and Solid Particles Filter.
- ② PVC-U $\Phi 50.\Phi 32$.
- ③ Dental suction's major pipeline and devied pipeline is connected by 45° corner piece with straight line.
- ④ Negative pressure suction pipe of dental unit's basic box should be 50mm higher than ground.
- ⑤ Dental suction's pipe should be deal up, inside of pipe must be cleaning.
- ⑥ Signal control wire adope $2*1.5$ square cable with parallel.
- ⑦ Signal control wire should no-voltage with electic shock signal.
- ⑧ Dental suction's room temperature should less than 40°C , Reliable ventilation.
- ⑨ Advice Dental suction's exhaust outlet to connect outside clinic's air pipe with $\Phi 38\text{mm}$.
- ⑩ Dental suction should have drainage outlet with $\Phi 25\text{mm}$.

7. Troubleshooting

Trouble	Cause Analysis	Solution
The suction system is unable to boot.	If the power supply is plugged in properly.	Plug in the power supply.
	If the power supply switch is on.	Switch on the power supply.
	The control switch of the dental treatment devices failed to turn on.	Check or replace.
The suction efficiency is reduced.	There may be a jam at the inlet of the suction system.	Clean the filter screen.
	The pipes on the dental chair may have air leakage.	Inspect all the suction pipes and joints on the dental chair.
The motor is overloaded.	If the voltage is too low.	Check the power supply.

8. After-sales Service

8.1 Free services and repairs arising from quality problems will be provided for this device within one year since the date of purchase.

8.2 Free services and repairs will not be provided within the warranty period in any of the following cases:

- ① Failures caused by installation or use that hasn't followed the requests in this Manual;
- ② Man-made damages caused due to collision, falling, etc.;
- ③ Failures arising from the user's own disassembly;
- ④ No warranty card or certificate of purchase, or the card or certificate is altered.

1. Function Description

Its power system uses a wide-voltage dual-frequency motor in Grade IP55 protection (insulation grade: F) as its driver, to provide swirl-type circular suction with lower noise, higher pressure and larger flow.

Its filter system adopts the most advanced mechanical filter technology in terms of the current water treatment process, which can effectively remove the inhaled gel or other solid particulates.

Its effective two-level water-gas separator, with high bubble compatibility, could effectively prevent the fluid and blood in pipes being sucked into the pumping motor.

Configured with multiple layers of protection overload, and pressure relief safety devices, so that the device longer life.



► This device should be used with a dental curing device to remove droplets, spit and food residue in the patient's mouth.

2. Safety Measures

2.1 Important safety signs







This section provides the explanations on "warning" and "attention". These warnings, safety precautions and important safety instructions described later don't cover all possible conditions.

Meanings of marks and signs for this device:



	Caution!
	Unsafe operation may lead to personal injury and property loss!
	Warning!
	The internal live components must not be operated before the power is cut off!

	Caution!
	<p>The device surface may have a high temperature. Never touch it with your bare hands!</p>

Meanings of marks and signs for this device:

-  Warning: Dangerous or unsafe operation that may lead to serious personal injury or death;
-  Attention: Dangerous or unsafe operation that may lead to slight personal injury or property loss.
-  Do don't attempt!  No disassembly by yourself!
-  Keep grounding to prevent electric shock!
-  Please unplug the power plug!  Please follow the instructions!

2.2 For installation

-  Attention: Please make clinic's pipeline according to pipeline drawing with mention item, it can increase the flow of suction entrance, Reduce flow damage in the pipeline, effective use negative pressure of dental suction, let patient have the better experience.
 - ▶ If don't make clinic's pipeline according to pipeline drawing with mention item , it is result in flow problem, suction effect is not good or abnormal suction .
-  Warning: He suction system is for indoor use only, so please don't install it near a heater or flammable materials, or in a damp, oily or lace with leakage of inflammable gas.
 - ▶ If not, an electric shock or fire may be caused.
-  Warning: Please don't install this device in a small, closed place, or a place

Attention: please check if the filter screen is tightly installed on the device after cleaning, or the water and leakage may occur.

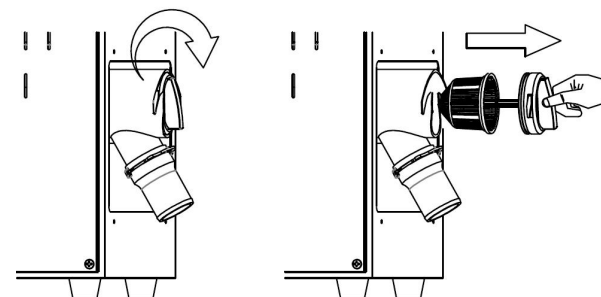

6.3 Pipeline cleaning

Before cleaning, please put back the cleaned filter screen on the device and then check if all the pipes have been connected properly.

Please don't clean pipes with detergents with bubbles or corrosive agent. Using such detergents may lead to backflow, damaging the motor of the suction system.

- ▶ Prepare a cleaning solvent with medical multi-enzyme washing concentrate on a 1:100 ~ 1:300 basis according to the pipe contamination degree.
- ▶ Power on the suction system and switch it on and then pump the prepared cleaning solvent to pipes from the strong and weak suction pipes on the dental chair for cleaning.

6.4 Fan maintenance

If the device is not used for a long time, please empty the liquid in the water-gas separator's cavity and then make the fan operate with no load for 30 minutes, to prevent reducing its suction performance due to oxidation arising from not in use for a long time.

- ▶ Remove the hose clamp at the water inlet and then pull the pipe.
- ▶ Connect the signal line to have the device operate with no load for 30 minutes.

remove the strong or weak suction pipe on the dental chair and then the suction machine begins to work.

6. Cleaning and Maintenance

Regular maintenance for the dental suction system could reduce the frequency of troubles and keep this device in good working condition, thus extending its service life.

The operator must wear a mask and waterproof gloves in cleaning and maintaining.

△ The following operations must not be carried out after the power is cut off!

6.1 External cleaning

Be sure this device has stopped operating, and the power supply has been cut off and unplugged before cleaning.

- ▶ Please immerse a soft towel into warm water and then wring it dry to wipe the device surface.

Attention: please don't wipe the control panel with alkaline detergent.

Attention: wiping the device surface with a coarse or stained cloth with particles may scratch this device, so please use a tidy soft cloth to clean.

6.2 Filter screen cleaning

It is recommended to clean the filter screen twice a week to prevent reducing the sucking efficiency.

Be sure this device has stopped operating, and the power supply has been cut off and unplugged before cleaning.

- ▶ Remove the filter screen from this device by rotating clockwise as illustrated and then rinse it thoroughly with clean water.

Attention: if there is any adhesive matter on the filter screen, please brush away it with a soft brush to prevent damaging the screen.

where no room temperature could be adjusted.

- ▶ If not, its service life may be reduced or the device may suffer from failures.

 Attention: The suction system must be installed on a flat, solid surface that can bear its weight for use.

- ▶ If not, abnormal vibration, noise or product failures may occur.

 Attention: Check if there is a jam at the water inlet or air outlet.

- ▶ If not, the working efficiency of the suction machine may be reduced or some failures may occur.

2.3 For power supply

 Warning: Please connect the power line to a wall socket that meets the specification (AC220V) described here for this device, and the wall socket is exclusive for this device. In addition, this device must be grounded reliably.

- ▶ If the multi-socket power board shares a wall socket or power line with other electrical appliances, an electric shock or fire may occur.
- ▶ If any difference in rated voltage, frequency or current, an electric shock or fire may occur.

△ When the following operations must disconnect the power!

 Warning: Please insert the power plug into the wall socket firmly. Please don't use the damaged power plug, power line or the loose wall socket.

- ▶ If not, an electric shock or fire may occur.

 Warning: Please don't pull the power line in unplugging electrical appliances.

- ▶ Hold the plug and then unplug.
- ▶ If not, an electric shock or fire may occur.

 Warning: please don't pull or excessively bend, coil or bind the power line. Never hang it on metal objects or place some heavy objects on it.

- ▶ If the power line is damaged, it is necessary to replace with a new one in the same specification to avoid dangers.
- ▶ Before cleaning or maintenance, the power supply of this device must be cut off .

 Attention: Please cut off the power supply in thundering or lightning or if this device will not be used for a long time.

- ▶ If not, an electric shock or fire may occur.

2.4 For operation

 Warning: If some water penetrates into this device after its pipes have been closed, please cut off its power supply and then contact our after-sales service department.

- ▶ If some abnormal noise, burning smell or smoke occurs in the suction system, please cut off the power supply quickly and then contact our after-sales service department.
- ▶ If not, an electric shock or fire may occur.

 Warning: If any leakage of inflammable gas (such as propane gas, liquefied petroleum gas, etc.), please ventilate instantly and don't touch the power plug.

- ▶ Please don't use the ventilating fan.
- ▶ The spark may lead to an explosion or fire.

 Warning: Never touch the power plug with your wet hands.

- ▶ If not, an electric shock may occur.

 Warning: After unpacking, please keep all the packing materials out of the reach of children.

- ▶ Suffocation may be caused if a child puts his or her head into the packing bag.

 Warning: Please don't insert your fingers or foreign matters into the water inlet or air outlet.

B Connection of exhaust pipe

Please connect one end of the provided **exhaust pipe** with the **air outlet** on the back of the suction system:

- ▶ Hold one end of the **exhaust pipe** and then rotate it inward to connect to the **air outlet**.
- ▶ Fasten it with the provided **metal hose clamp**.
- ▶ Then, connect the other end of the **exhaust pipe** to the exhaust hole (or the preset exhaust manifold) on the wall.

Note: the exhaust pipe temperature will rise obviously when the suction system is working, so please use a metal pipe or heat resistant tube that could withstand an 80°C high temperature as the exhaust extension tube.

C Connection of drainage pipe

Please connect one end of the provided **drainage pipe** with the **water outlet** on the back of the suction system:

- ▶ Hold one end of the **drainage pipe** and then rotate it inward to connect to the **water outlet**.
- ▶ Fasten it with the provided **metal hose clamp**.
- ▶ Then, connect the other end of the **drainage pipe** to the sewer pipe.

Note: the drainage pipe in clinic cannot be installed higher than the water outlet.

D Connection of the suction system and the signal line of dental chair

The signal line used to connect this device to the dental chair is a multi-conductor line located near the power wire on the back of this device.

- ▶ Connect the signal line with the heavy-current and light-current control system switch of the dental chair.

5.5 Use after connection

- ▶ Power on, and turn on the green rocker switch at the lower right-hand corner on the device front, the power indicator light and the monitor will be on and the suction system enters a standby mode.
- ▶ After confirming the signal switch on the back of the suction system

5.2 Installation conditions

- ▶ Indoor: solid and flat ground without any shake.
- ▶ Clean environment with good ventilation and without direct sunlight and harmful, corrosive gas.
- ▶ It is recommended to provide a ventilator and some air outlets with a diameter of 38mm in the room where this device is installed, to discharge the exhaust gas and guarantee the fresh indoor air.
- ▶ In addition, an underground sewage pipe with an inner diameter of 25mm should be equipped in the room to guarantee the removal of liquid waste from the suction system.
- ▶ This device should be installed near the power socket with reliable grounding.
- ▶ Keep this device far away from heat. No inflammable materials near it. Enough space should be provided near the suction system for ventilation.
- ▶ No direct or indirect contact with damp objects is allowed in the installation site.

5.3 Requirements for normal operating environments

Ambient environment: +5°C -- +40°C

Relative humidity: ≤70%

Atmosphere pressure: 700Hpa ~ 1060Hpa

5.4 Pipeline/signal line connection

A Connection of air intake pipe of the suction system

Please first connect the provided **inlet pipe** with the **water inlet** of the suction system:

- ▶ Operate with your both hands: one holds the water inlet of the suction system and the other holds the inlet pipe and then rotate it inward.
- ▶ Then, fasten it with the provided **metal hose clamp**.
- ▶ Connect the other end of the **inlet pipe** to the strong and weak exhaust pipes (or the preset underground main) on the dental chair.

- ▶ is on, Please be cautious that you may be injured or this device may be damaged if you do what mentioned above. The operating device will cause quite high temperatures at the air outlet and on pipes connected with the air outlet, so a burn may occur.



Warning: Please don't beat or pull this device forcefully.

- ▶ If not, an electric shock or fire may occur.



Warning: Please don't repair, disassemble or refit the suction system.

- ▶ If not, an electric shock may occur or this device may be damaged or have failures.



Warning: Please don't stand or put heavy objects and hazardous articles (such as lighted candle or cigarette, corrosive chemicals, etc.) on this device.

- ▶ If not, a fire may occur or this device may be damaged or have troubles.



Warning: Please don't touch the motor's cooling fins after the device starts working, as they will generate high temperatures gradually; don't coil the power line on the motor or contact it with the motor's metal parts.

- ▶ If not, a burn, fire and electric shock may be caused.

2.5 For cleaning



Warning: Please don't clean the surface of this device before the power is cut off.

- ▶ If not, an electric shock may be caused.



Warning: Please don't clean by directly spraying water to the suction system. Please don't clean this device with benzene, diluent or alcohol.

- ▶ If not, the device appearance may be discolored or an electric shock or fire may be caused.



Warning: Please don't clean pipes with detergents with bubbles or corrosive agent.

- ▶ Using such detergents may lead to backflow, damaging the motor of the suction system.

2.6 For environment

After this device is discarded, the disposing must follow the local regulatory requirements. Please contact your local recycling center or the national recycling organization for more information.

2.7 EMC

Please keep this device far away from the portable and mobile radio-frequency transmitting device including their cables. When this device is placed near the devices with the mark shown on the right, this device may be interfered.



3. Main Components

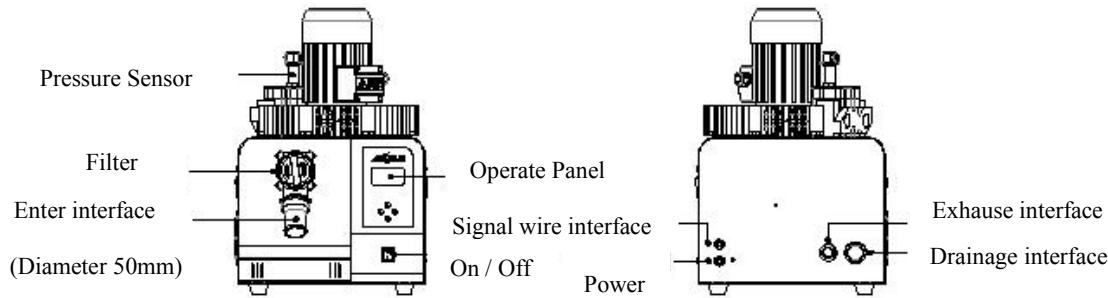

4. Main Product Parameters

Type	
Voltage (V)	220±10
Frequency (Hz)	50/60
Power (KW)	1.3/1.5
Rated current (A)	3.5/3.8
Motor speed (r/min)	2800
Maximum pressure (KPa)	38
Maximum vacuum (KPa)	-30
Number of dental chairs (pcs)	5
Noise (db)	69
Product weight (kg)	41
Package Weight (kg)	59.5
Product size (cm)	51*41*63
Package size (cm)	51*48*79

Note: the produce design and specification may be altered for improvement without any further notice.

5. Product Installation

5.1 Unpacking

After unpacking, please check if the device is damaged during transport and the accessories described in the packing list are complete. If any damage or missing of the accessories, please contact our dealer timely.

Parts and accessories provided with the device:

- Pipe-----3 pcs
- Metal hose clamp-----6 pcs
- User manual-----1 copy
- Certificate of conformity-----1 copy
- Warranty card-----1 copy