

DENTAL UNIT

USER MANUAL

Table of contents

1. SPECIFICATIONS.....	3
2. SYMBOLS.....	5
3. Installation preparing.....	5
4. QUICK START.....	9
5. DENTAL PATIENT CHAIR AND DELIVERY SYSTEM.....	12
8	
6. ASSISTANT TRAY & WATER UNIT.....	18
7. SPECIFICATIONS.....	21
8. OPERATING LIGHT.....	23
9. SUGGESTION FOR CLEANING AND HYGIENE.....	24
10. INTRODUCTION OF EMC.....	27
11. WARRANTY.....	30
12.CIRCUIT SCHEMATIC DIAGRAM.....	31
13. WATER GAS CONNECTION DIAGRAM.....	32
14 . TROUBLESHOOTING.....	33
15.PACKING AND ACCESSORIES LIST.....	34

INTENDED USE

The dental unit is intended to supply power (electrical, air, water, etc.) to and serve as base for other dental devices, such as a dental handpiece and other dental accessories. It is intended for use in the dental clinic/office environment and used by trained dentists and/or dental technicians and assistants. This product is attached with a dental chair.

TRADEMARKS AND ADDITIONAL INTELLECTUAL PROPERTY RIGHTS

None of the trademarks or trade names in this document may be reproduced, copied, or manipulated in any manner without the express, written approval of the trademark owner. Certain touchpad symbols are proprietary to . Any use of these symbols, in whole or in part, without the express written consent of , is strictly prohibited.

CONTRAINDICATION

NO.

PRODUCT SERVICE

Product service is available through your local authorized dealer.

WASTE AND RECYCLING INSTRUCTIONS

Waste should be disposed of according to the medical waste disposal. Please comply with the local regulations.

Recycle and disposal of the product shall be carried out by qualified institutions or individuals in accordance with local regulations.

1. SPECIFICATIONS

1.1 product mix

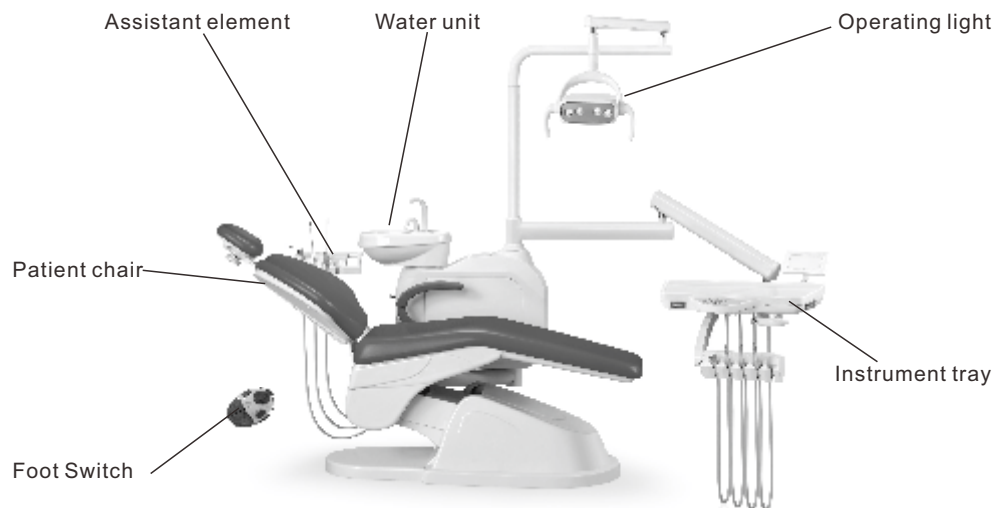

1.2 Product parameter



IMPORTANT:

For chair accessory load capacity, electrical specifications, identification of symbols, and other regulatory requirements, refer to the data plate included with your equipment.

In order to make sure the normal use of the machine, the input water, air, power supply and its work conditions shall meet the following parameters:

- (1) Air supply: 0.55~0.75Mpa, >50L/min, Aperture size of the filter element:20µm oil contamination limit<0.5 mg/m³, particulate contamination limit :not greater than 100 particles per cubic meter for 1 µm to 5 µm particle size.
- (2) Water supply:0.25~0.6Mpa, >10L/min, Aperture size of the filter element:60µm.
- (3)Power supply: a.c. 230 V, 50 Hz, 1200 VA, protective grounding.
- (4)Environment:temperature 10°C ~ 40°C, relative moisture 30% - 80%; pressure altitude ≤ 3000 m.
- (5)Operation space:≥1.37m (L) × 0.94m (W) × 1.1m (H); the ground is smooth and oblique angle less than 0.5° (6)Transportation conditions up,handle with care, anti-moisture.
- (7)Transportation environment:temperature -40°C ~ +70°C,relative humidity 10% ~95%.
- (8) Storage environment:temperature -40°C ~ +70°C,relative humidity10% ~95%. corrosive gas and well ventilated indoor.

- (9) Product shipment:no more than two wooden boxes when transporting or storing wooden stacks. (10) The inlet water connection is equipped with 8x5 tee joint or ball valve, one of which is used for water sampling port.
- (11) Product service life: 8 years.



NOTE

We reserves the right to ma any improvement on product design without advance notice. Requirements may vary depending on your location. For more information, contact your local authorized dealer for available operating light maintenance parts.

Basic parameter

Mass of equipment	250 kg	The maximum height of cushion	700mm
Maximum load	150 kg	Backrest adjustment angle	95° ~ 170°
Input voltage	AC 230V 50Hz	Air supply pressure	0.55~0.75MPa, >50L/min, Aperture size of the filter element:20µm
Rated power	1200VA	Water supply pressure:	0.25~0.6MPa, >10L/min, Aperture size of the filter element:60µm
Operation mode	T_on:2min T_off:18min	Water supply:	2L/min
Flush phlegm flow	2L/min	Thermostatic temperature	(40±5)°C
Water flow of the spittoon	4.5L/min	Strong suction flow rate	1.8L/min
Scope of instrument disk activity	400mm	Weak suction flow rate	0.42L/min
The minimum height of cushion	500mm	Dental operating light	25000Lx
Foot switch	degree of protection against ingress of water: IPX6	Degree of protection against electrical shock	Class I, type B applied part
Air consumption	155L/min	Width	910mm
Min. installation space	3900mm×3010mm	Equipment rotating Angle	145°
Assistant rod rotation Angle	90±5°	Assistant lever frame rotation Angle	90±5°
Arm length	625mm	Arm rotation Angle	105±5°
Balance arm length	655mm	Balance arm lifting height	400mm

2. SYMBOLS

NAME	SYMBOLS	NAME	SYMBOLS	NAME	SYMBOLS
WARNING		IMPORTANT INFORMATION		RADIO WAVE EMISSION	
CAUTION		REUSE PROHIBIT		CHAIR UPWARD	
NOTE		SETTING		CHAIR DOWNWARD	
DANGER		RESET		BACKREST FORWARD	
BOWL RINSING		RINSING POSITION		BACKREST BACKWARD	
OPERATING LIGHT		CUP FILLER		PRESET POSITION GROUP	
FILM VIEWER		WATER HEATER		PRESET POSITION	

3. Installation preparing

3.1 Installation condition.

In order to normally use the device, input the gas, water, electricity and environmental requirements of the device as follows:

Air supply : 0.55~0.75Mpa, >50L/min
 Water supply: 0.25~0.6Mpa, >10L/min
 Power supply: A.C 230V, 50Hz

3.2 air source and water quality requirements.

Provided air and water must conform to the requirements in the installation instructions. It can only supply water and dry, oil-free medical gases in accordance with medical and national laws.

If water hardness is higher than 12°d H (equal 2.15mmol/l), you must use the softener and adjust the water hardness inputted in dental chair to 8°dh (equal to 2.15 mmol/l). In order to ensure that the treatment machine water is in compliance with medical and national legal requirements, commands to install disinfection system for the treatment machine and respond to water quality as the owner of the machine; if you do not install disinfection system, other measures are also needed to ensure compliance.

3.3 site layout requirements.

3.3.1 When the conditions permit, the ground is reserved for 25cm*25cm and the depth is 10cm.

3.3.2 Power requirements: 220V 10A, with five hole, two, three.

3.3.3 Water supply requirements: interface with two-pass ball valve, the interface thread is 4 internal thread.

3.3.4 Air supply requirements: interface with two-pass ball valve, the interface thread is 4 internal threads.

3.3.5 If you use central negative pressure system, you need reserved negative pressure tube, and the negative pressure pipe is 4 points PVC to the water pipe, and purchase selector switch installation by yourself.

3.3.6 Pipeline requirements:

- (1) The lower pipe is a 50mm diameter PVC drain pipe.
- (2) The lower pipe is 4 points PVC to the water pipe.
- (3) central negative pressure tube is 4 points PVC to the water pipe.
- (4) The central negative pressure system signal line is 0.75 square 2 core.
- (5) The power cord is 2.5 square cores, and the ground wire is 1.5 square.

3.4 Tube layout requirements

3.4.1 Piping shall be lower than ground installation.

3.4.2 The safety of the drainage channels shall comply with specification for outdoor drainage design: 1 meter sink 5mm slope.

3.4.3 The minimum flow of drainage pipe shall not be less than 4.5l/min.

3.4.4 The whole pipeline joint is installed in the 180mm, width 220mm (figure 1).

3.4.5 Water source, air source switch, negative pressure pipe should be higher than the ground installation, ball valve top the ground height is not higher than 120mm, drain pipe mouth should be higher than pipe diameter 1.5 times. (figure 2)

3.4.6 The spittoon drain pipe, the strong suction drain pipe must be independently connected to the waste water pipe, cannot and pipe thick access.

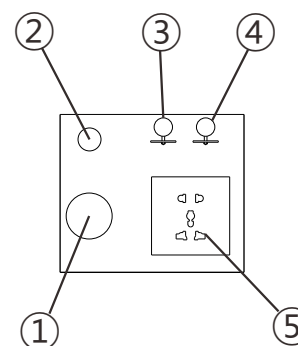

figure 1

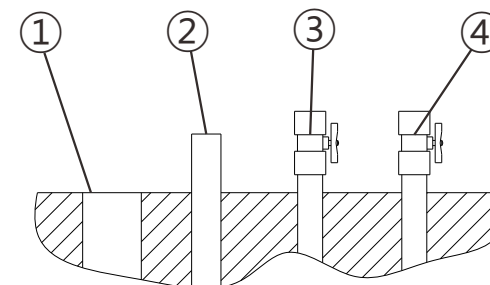
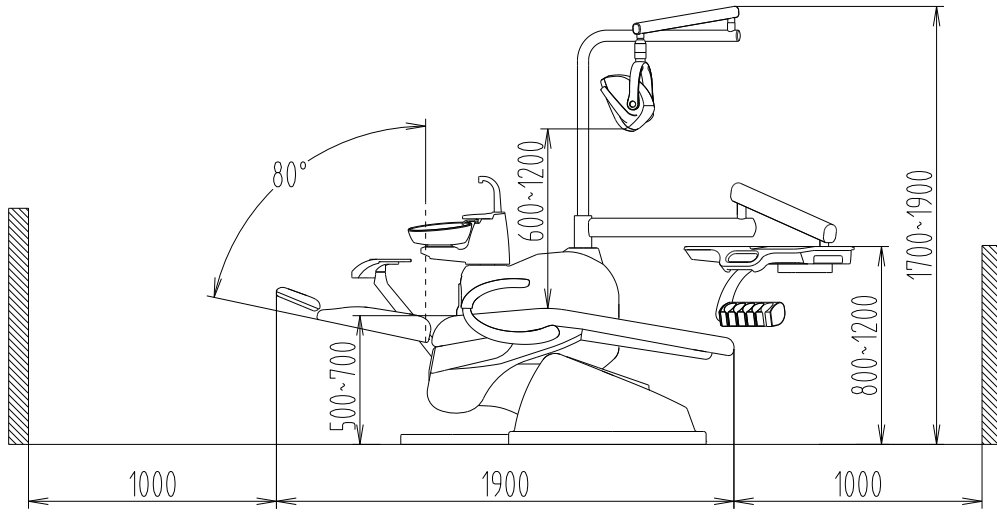

figure 2

①	②	③	④	⑤
50mm(PVC) Sewage pipe	½ inch(PVC) Negative pressure tube	Air source ½ inch Internal ball valve	Water source ½ inch Internal ball valve	Five-hole socket

DENTAL UNIT

The installation diagram is as the following:



Overall dimension of the dental unit

DENTAL UNIT

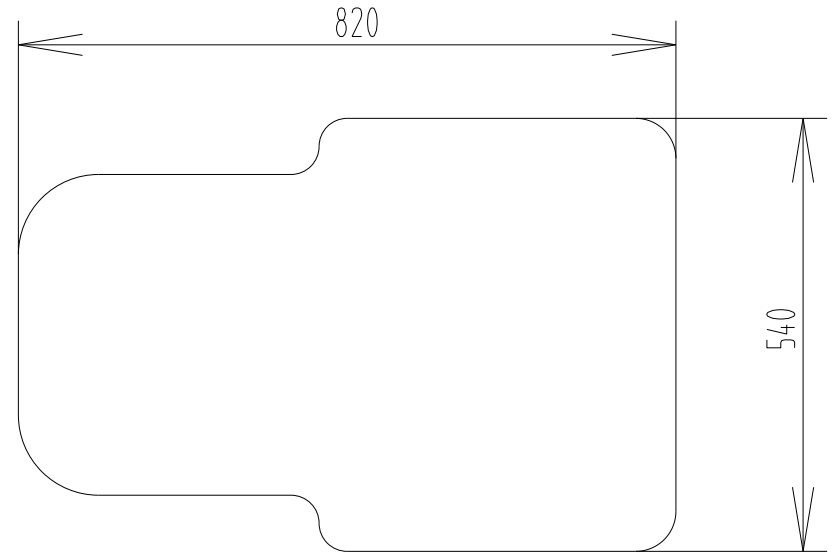

Overall dimension of base

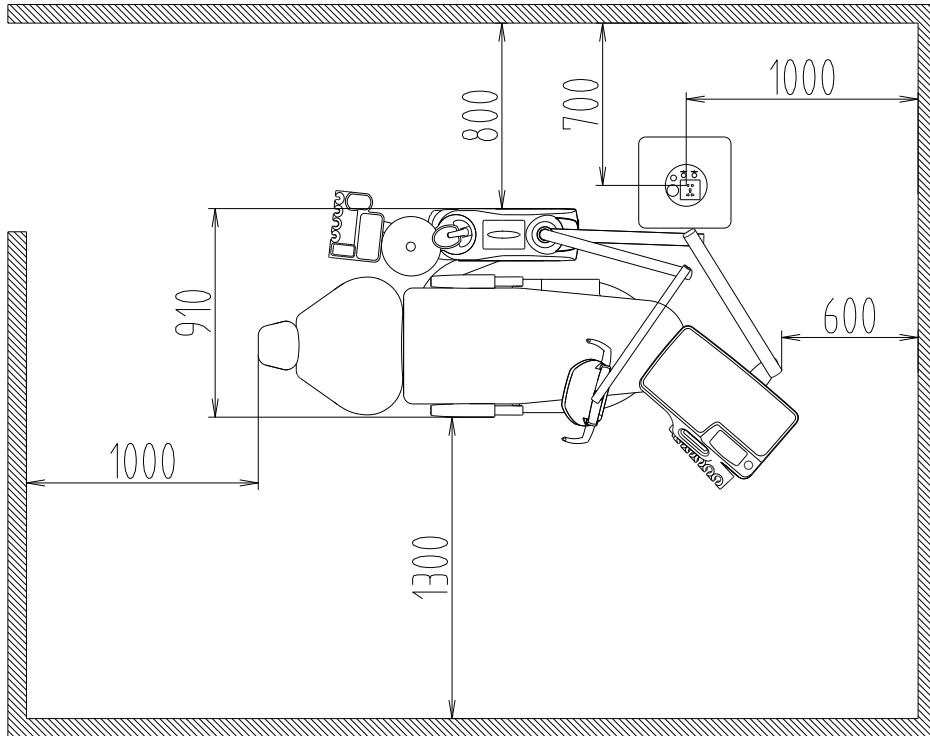

installation layout

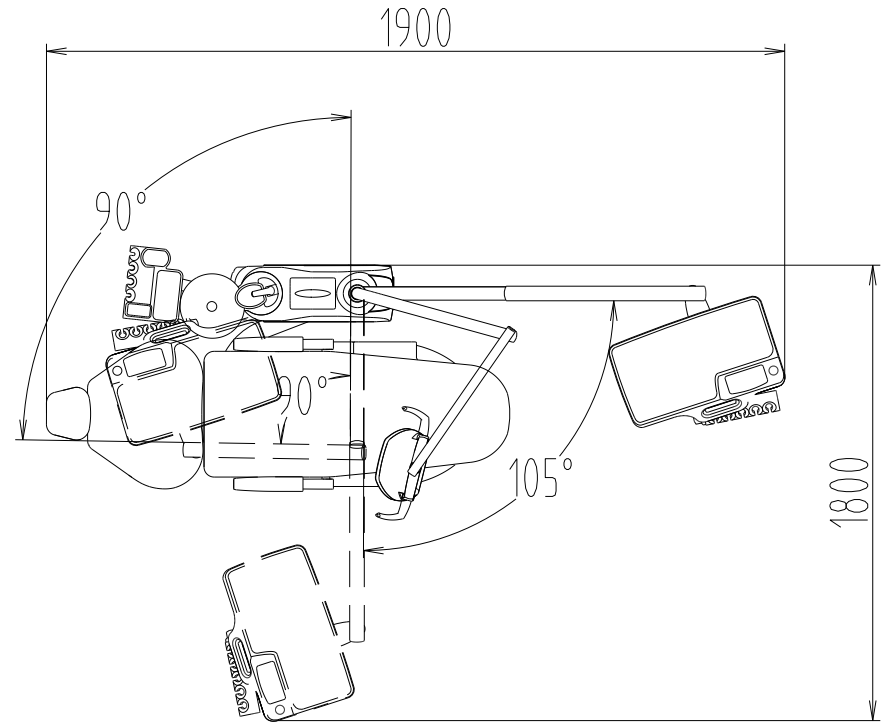

Scope of activities

DENTAL UNIT

e) device installation

- According to the overall layout of the diagnosis and treatment room, lighting, convenient use and so on, determine the installation position of the equipment.
- The equipment should be kept in a clean, dry, ventilated and cool place, so that it is in a good working environment, and the ground level of the electric dental chair floor is guaranteed to be firm.
- Then choosing right position which ensure electrical dental chair cannot touch anything throughout the movement.
- Before sampling the water, please open the water tap and draw off the water for 30 seconds. And then sample the water and store in sterile water bottle. And the water shall be analysis within 24 hours. The water quality shall comply with sanitary requirement for medical water in local medical institutions

⚠ CAUTION

- Prior to disassembly / disposal of the product, it must be fully prepared (cleaned / disinfected / sterilized).
- No hydrargyrum segregator has been installed within the product; therefore, its drainage system cannot filter amalgam alloy. In order to avoid such pollution to the drainage system, the user shall install a hydrargyrum segregator additionally to avoid the drainage pollution,
- Interface size 12mm.

4. QUICK START

4.1 Move the main control lever to “on” to turn on the water, gas and electric of dental unit .



4.2 Check the water bottle and fill it when the water is about to run out.



(For more instructions on the pure water system, go to P.17.)

4.3 Turn on the light power through the light button on the control panel.

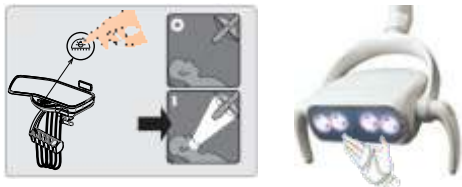

DENTAL UNIT

4.4 Press and keep the on/off switch to disengage the balance arm brake and adjust the height of the instrument tray. Disengage the switch to lock the position.

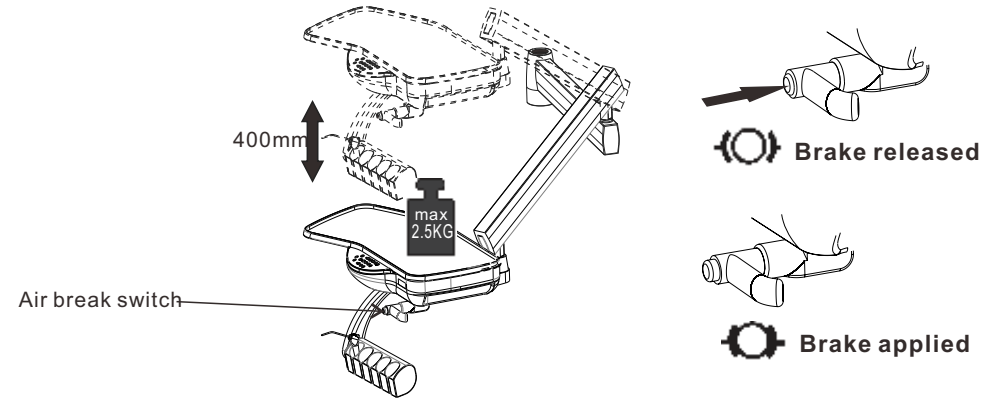

4.5 Pick up the handpiece and step on the foot controller to operate.

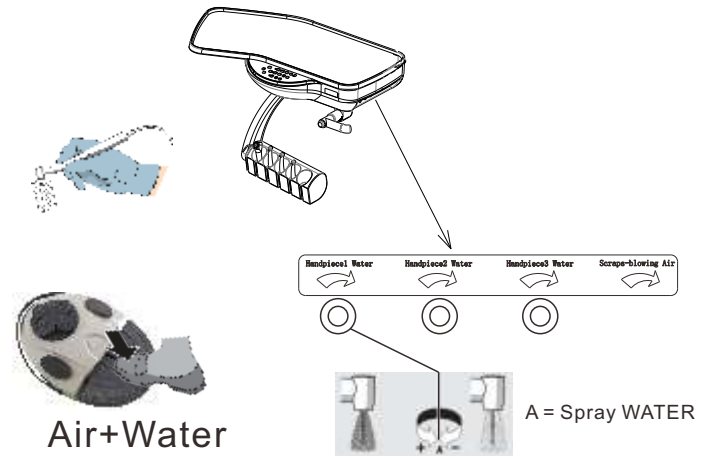

Press the air switch and water switch on the Foot Switch and adjust the adjusting knob on the Instrument tray to achieve the required working air pressure.

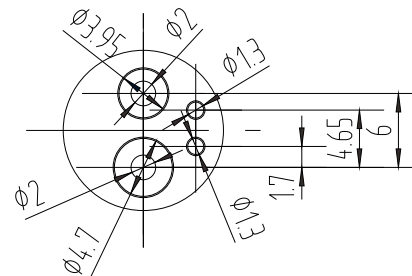

handpieces the hose connector

DENTAL UNIT

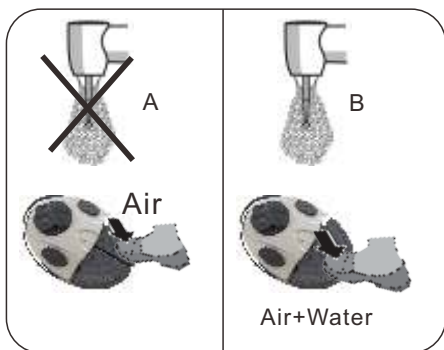

⚠ CAUTION

Do not operate the instrument without spray.
Always place the instrument back in the correct holder.

ℹ NOTE

Also observe the operating instructions for the treatment instruments.

⚠ CAUTION

Use only treatment instruments approved by Gladent!

⚠ CAUTION

Put the Hose connectors for air driven dental handpieces in order.

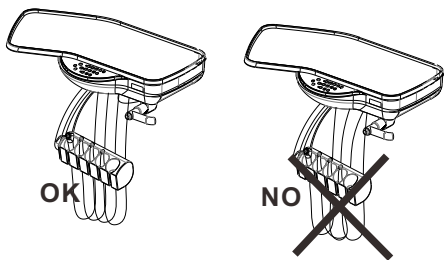

4.6 Start/stop the water filler or bowl rinsing function through the button on the control panel.

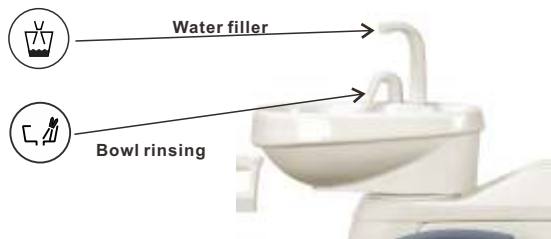

4.7 To install the syringe tip, push in the tip until you feel two clicks. Press both buttons simultaneously for the 3-way syringe.*

1. Press and hold the pressure ring.
2. Push in the tip and release the pressure ring

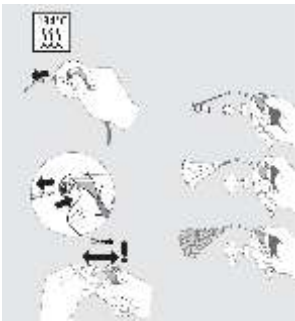

DENTAL UNIT

4.8 Pick up the suction handle from the assistant element, the suction system will start automatically.



4.9 Use the manual or programmable buttons to position the chair. For complete programming instructions, see P 15 and P 16.

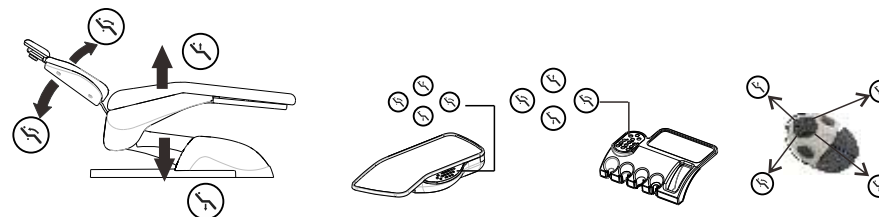

4.10 Use the control panel to activate associative function. For complete programming instructions, see P 15 and P 16.

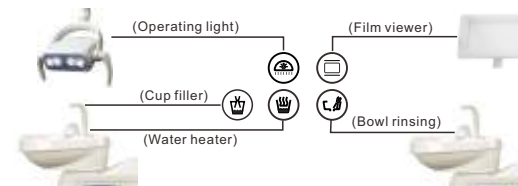

5. DENTAL PATIENT CHAIR AND DELIVERY SYSTEM

5.1 PATIENT CHAIR

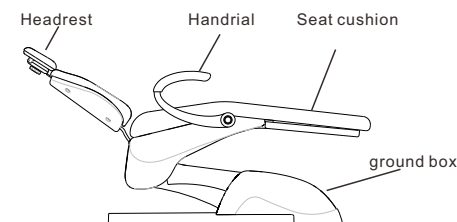

5.2 DELIVERY SYSTEM

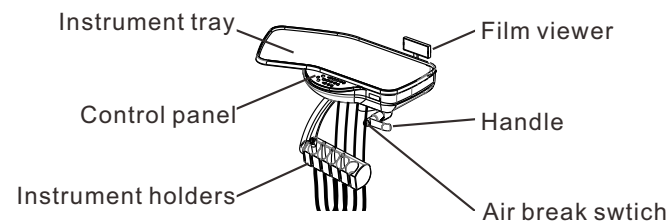

DENTAL UNIT

5.3 POWER AND SYSTEM STATUS

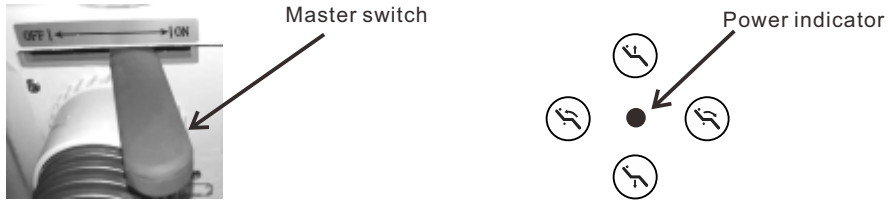

The chair and system power is controlled by the Master toggle on the delivery system.

To save energy, turn the power off at the end of the work day and during longer periods of non-use. The power should always be turned off before service.

When the power light on the control panel of dental unit illuminates, the system is on and ready for use.

5.4 SAFETY FUNCTION

5.4.1 Chair-instrument interlock system.

The patient chair movement will be locked during operation of instruments. Release foot pedal, chair movement unlock.

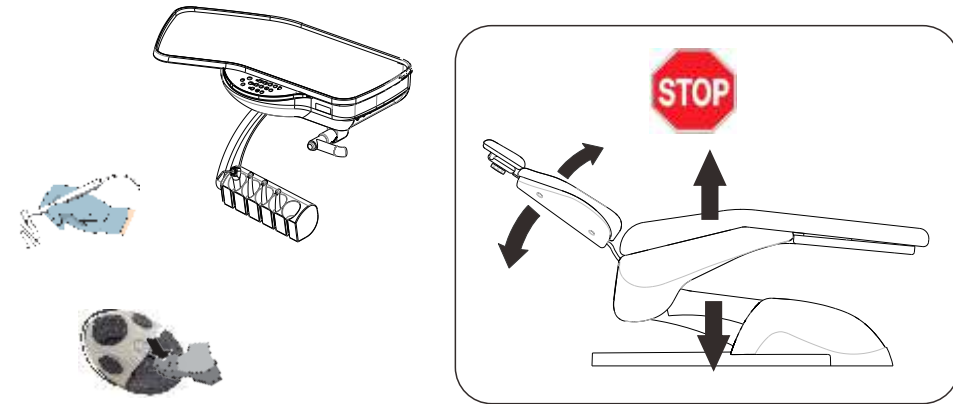

5.4.2 Emergency stop function

In an emergency, press the emergency stop switch and the movement of the Dental Unit will be locked

DENTAL UNIT

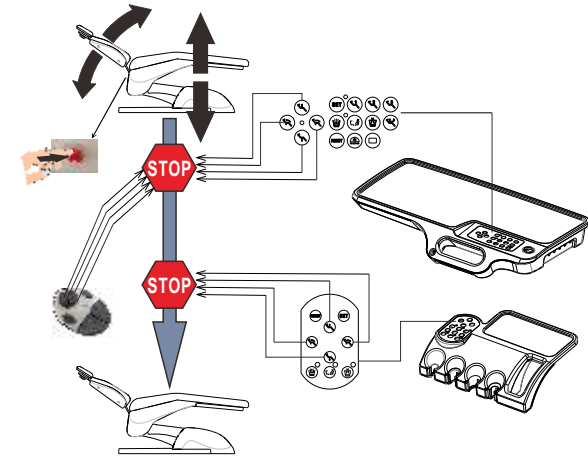

5.5 Adjusting the armrest

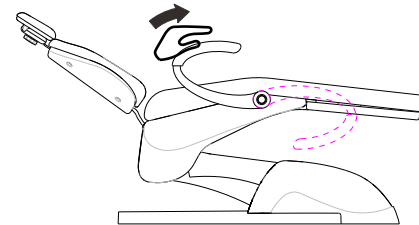

Folding armrest (option)

5.6 DOUBLE-ARTICULATING HEADREST

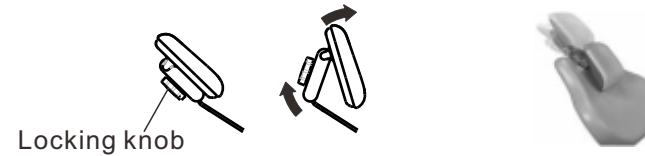

The locking knob allows you to secure the headrest in a full range of positions. Release the headrest by keeping pressing the locking knob. Then adjust the headrest for a proper fit. Lock the headrest in the desired position by releasing the knob.



For height adjustment, slide the headrest and sliding guide up or down.



WARNING: When the sliding guide has reached its maximum recommended working height, limit screw of sliding guide will limit the sliding guide outward. Do not use the headrest in a position where is found limit.

5.7 Function description and settings

5.7.1 Control panel

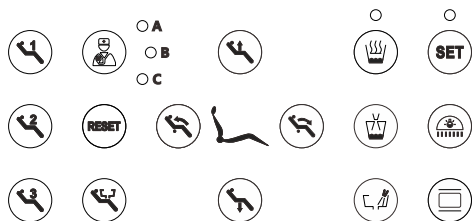

You can operate the chair manually or by using programmed presets from the foot switch or control panel.

5.7.2 Function settings

5.7.2 Mouthwash water supply setting

- (1) Long press **SET** three seconds, set the indicator light up, the system enters the setting state.
- (2) Long press **M**, the water supply begin to feed; when the water in the cup reaches the water requirement, release the key and stop the water supply.
- (3) Press **SET** key once, setting the indicator to go out, the system state, and the setting is finished. When used, just click on **M** key, the system will automatically supply water to the set of water in the cup. If you press **M** key in the process of water supply, the system automatically interrupts water supply.
- (4) Adjusting the water supply according to the above steps if the tap water pressure changes significantly or when the cup size is changed.

5.7.3 Reset key **RESET**

When a patient is going to see a doctor or after the treatment, as long as gently press the **RESET** key, electric dental chair immediately run to the initial state, chair frame fell to the lowest limit position, back of a chair forward to limit position, reduction process, click on the arbitrary direction key, the system stop this action immediately.

5.7.4 Flush time setting

- (1) Long press **SET** three seconds, set the indicator light up, the system enters the setting state. Press **C**, the spittoon begins to flush, and the time is set to 5 minutes; press two times in a row, and the flushing time is set to 15 minutes. Press three times in a row, and the flushing time is set to 15 minutes. Press four times in a row, and the flushing time is set to unlimited time.
- (2) In the process of flushing, press the **C** key system to stop flushing automatically.

5.7.5 Preset key **PRESET**

Pressing the **PRESET** key, the chair frame automatically runs to the highest position, the back of the back automatically runs to the lowest, press any direction key, immediately stop the action.

5.7.6 The function of mouthwash heating

The device does not have an automatic thermostatic water heater device. If use warm water, press the **M** key gently, the indicator light is on, the water heater enters the working state. (Indicating that the light is on, indicating that it is heating; after the water temperature reaches the reservation value, the indicator lights go out automatically. When the temperature drops, the water heater will start working automatically and the light will be on.)

5.7.7 Rise of dental chair

Press **U** key, the chair frame runs up; when you reach the desired position, release the button and the chair frame will stop running (If you hold down the key, the chair will stop automatically when it reaches the limit position).

5.7.8 Decline of dental chair

Press **D** key, the chair frame runs downward; when you reach the desired position, release the button and the chair frame will stop running (If you hold down the key, the chair will stop automatically when it reaches the limit position).

5.7.9 Backrest back

Press **B** key, the chair frame runs back; when you reach the desired position, release the button and the chair frame will stop running (If you hold down the key, the chair will stop automatically when it reaches the limit position).

5.7.10 Backrest forward

Press **F** key, the chair frame runs forward; when you reach the desired position, release the button and the chair frame will stop running (If you hold down the key, the chair will stop automatically when it reaches the limit position).

5.7.11 P1, P2, P3 preset treatment memory location settings

- P1** Set: press **SET** three seconds, set the indicator light up, enter the setting state, adjust the chair frame to the desired position, press **U** once, storage, press **SET** key once, and exit.
- P2** Set: press **SET** three seconds, set the indicator light up, enter the setting state, adjust the chair frame to the desired position, press **D** once, storage, press **SET** key once, exit.
- P3** Set: press **SET** three seconds, set the indicator light up, enter the setting state, adjust the chair frame to the desired position, press **B** once, storage, press **SET** key once, exit.

5.8 WATER/AIR ADJUSTMENT



Water coolant adjustment knob

Air coolant adjustment knob

Use adjustment knobs to adjust water and air flow to your dental handpieces. The plastic knob adjusts water flow to all dental handpieces. The metallic knob adjusts air flow to all dental handpieces.

(1) Lift the dental handpiece from the holder.

(2) Press the left/right foot control disk to activate the dental handpiece.

(3) Adjust the water coolant flow and driving airflow by turning the adjustment knobs. Clockwise to decrease flow and counterclockwise to increase flow.

i NOTE

Water and air coolant adjustment knobs are intended to completely shut off flow.

DENTAL UNIT

5.9 OIL COLLECTOR



Oil Collector

Service the oil collector on the delivery system once a week for normal use and more often for heavier use.

To service:

(1) Rotate off the oil collector cup which below the instrument tray and discard the old gauze.

⚠ CAUTION

Do not remove the filter foam located inside the oil collector cup. Filter foam can be taken out and cleaned with water and then put it back.

(2) Fold a new gauze pad (51 mm x 51 mm) into quarters and place inside the cover. 3. Reverse screw the oil collector cover closed.

5.10 TENSION ADJUSTMENTS OF BALANCE ARM ON INSTRUMENT TRAY

Hexagon wrench

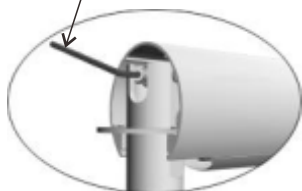

Remove the shell



Adjust the balance arm through these steps if the instrument tray slide up and down:

(1) Remove the shell.

(2) The instrument tray loads normal use objects, raise the instrument tray to the highest position.

(3) Use hexagon wrench to adjust the spring tension of balance arm until the instrument tray keep balance in normal position. Screw counterclockwise to reduce the tightness if the instrument tray slide upwards and screw clockwise to increase the tightness if the instrument tray slides downward.

5.11 Foot Switch

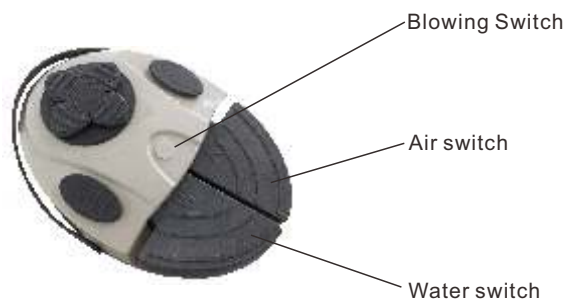

DENTAL UNIT

5.11.1 Foot Pedal:

(1) Take out the handpiece from the handpiece holder to prepare for the patient's treatment.

(2) Press the foot pedal on the air switch and water switch by foot, the handpiece will start. When the foot is removed from the foot pedal, the handpiece is turned off.

5.11.2 Blowing Switch:

(1) Take out the handpiece from the handpiece holder to prepare for the patient's treatment.

(2) Press foot on the blowing switch, airflow from handpiece spraying out to blow the debris. Removed foot from the blowing switch, the handpiece stops blowing.

6. ASSISTANT TRAY & WATER UNIT

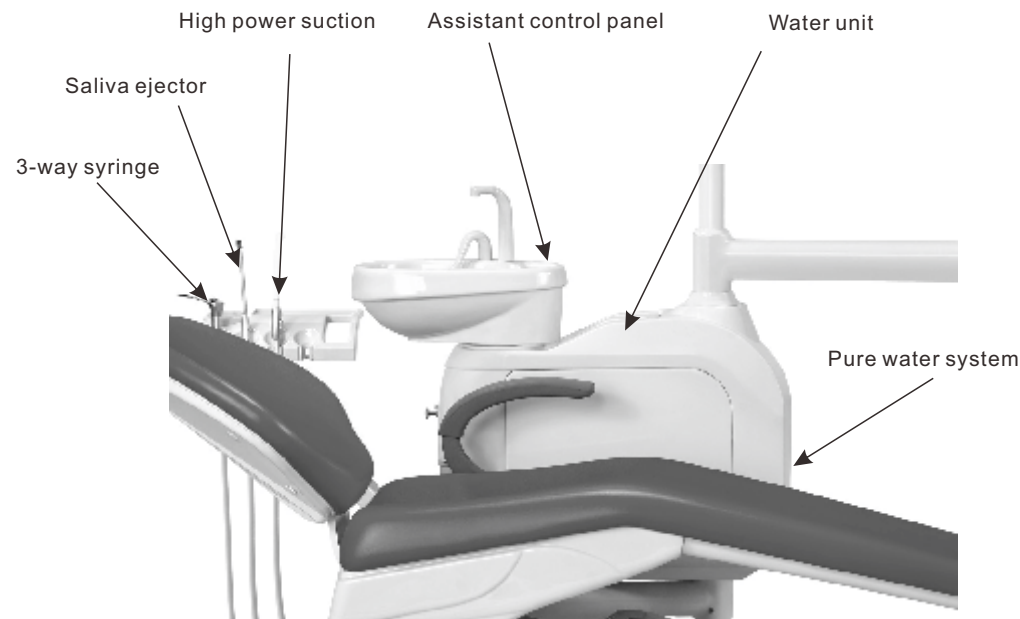

6.1 PURE WATER SYSTEM



Water bottle

⚠ WARNING

Use only ours Pure water bottles. Do not use other bottles, including glass or plastic beverage bottles. Do not use damaged bottles. These can pose a serious safety hazard while pressurized. We plastic water bottles cannot withstand heat sterilization. Attempting to do so will damage the bottle and your sterilize

Pure water bottle supplies water to dental handpieces and syringes. To remove the bottle, turn off the air pressure switch (turn to the air off position), and then revolve the bottle after the discharge of air pressure in the bottle.

DENTAL UNIT

For proper installation:

- (1) fill the bottle with water.
- (2) Insert the bottle.
- (3) tighten the bottle counterclockwise, taking care not to over tighten.
- (4) Turn on the air pressure switch. A pressurization sound may be heard up after the system is turned on

6.1.1 How to choose water source

Whether to use the Pure water system depends on the quality of water available from your municipal source. It's important to choose a source that consistently provides good water quality.

6.1.2 Tap water

If you have confidence in the quality of water from your municipal supply, consider using tap water.

6.1.3 Distilled water

If you have concerns about the quality of water delivered from your municipal supply, we recommend to use distilled water. When using a water distiller, carefully follow the cleaning and maintenance instructions for that device. Contamination may result if you do not follow the proper maintenance protocol.

⚠ CAUTION

Do not overtighten the bottle, otherwise you may damage the components. A pressurization sound may be heard up after the system is turned on and that is normal situation

6.2 SOLIDS COLLECTOR



⚠ DANGER

Infectious waste may be present. Follow asepsis protocol to prevent cross contamination.

To ensure proper suction power and to maintain proper treatment room asepsis, clean and replace the suction filter at least twice a week.

To replace the filter:

- (1) Turn off the suction pump.
- (2) Open the suction collector.
- (3) Remove the filter from the collector.
- (4) Discard the filter according to your local regulations.
- (5) Insert new filter into the collector and tighten the collector back .

⚠ CAUTION

Do not clean the filter in the cuspidor. Doing so could block the drain pipes.

DENTAL UNIT

6.3 SYRINGE NOZZLE CLEANING AND STERILIZATION

⚠ WARNING

Our syringe nozzles have been engineered and manufactured for use with our syringes. Use only our syringe nozzles in our syringes.

Using a syringe nozzle manufactured by a company other than ours may result in syringe nozzle ejection. Tip ejection may result in ingestion or aspiration of the nozzle, requiring immediate medical attention.

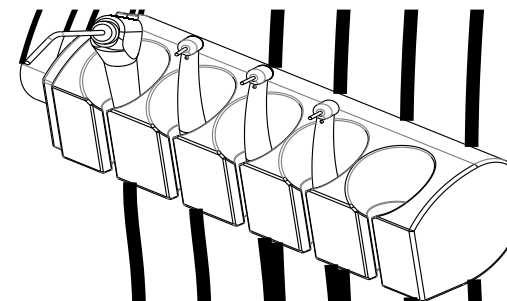

⚠ CAUTION

Disposable syringe tip cannot be disinfected, and cannot be reused



6.4 HIGH POWER SUCTION AND SALIVA EJECTOR ASEPSIS

6.4.1 If you use barrier film to protect the main body of the suction, clean and sterilize these instruments weekly, or more frequently as needed. If you do not use barrier film, or if you perform oral surgery, clean and sterilize these instruments after each patient.

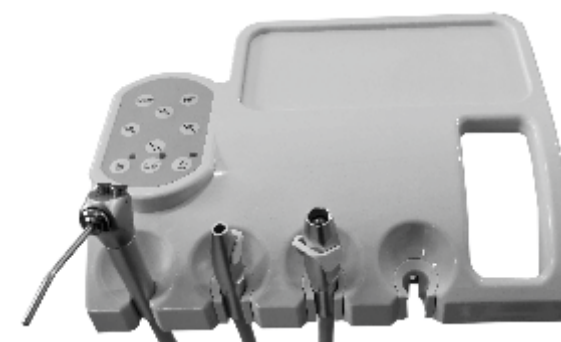

Saliva ejector

High power suction

DENTAL UNIT

6.4.2 cannula and cannula connector dimensions

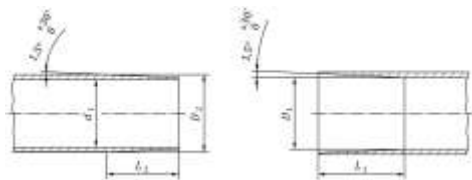

d1 nominal inside diameter cannula
 D1 inside diameter cannula connector
 D2 outside diameter cannula
 L1 inside taper length cannula connector
 L2 outside taper length cannula

b) Cannula connector

Table 1 — Example of dimensions of interface between cannula and cannula connector
 Dimensions in millimetres

d_1	D_1	D_2	L_1	L_2
15 ± 1	$14,9 + 0,2$	$16,1 - 0,2$	$18 - 1$	$15 - 1$
11 ± 1	$10,9 + 0,2$	$12,1 - 0,2$	$18 - 1$	$15 - 1$
≥ 6 for medium-volume suction system	Dimensions and tolerances given by the manufacturer			

CAUTION
 Disposable suction tips are not sterilizable and should not be reused.

CAUTION
 Use only petroleum-based lubricant on red O-rings. Silicone lubricants can damage the material.

7. SPECIFICATIONS

7.1 SPITTOON

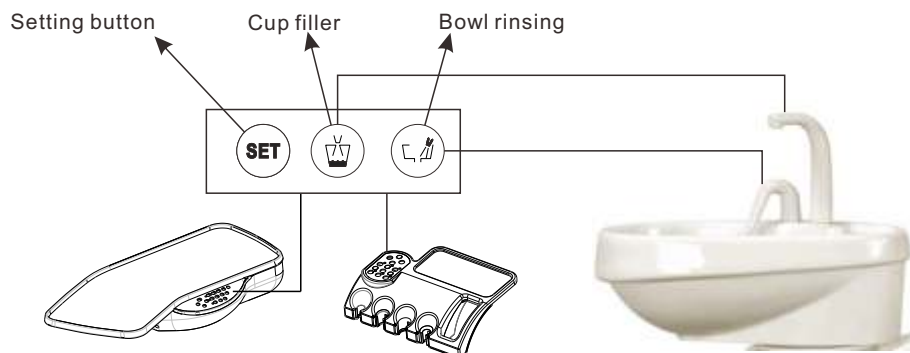

The cup filler and bowl-rinsing timing depends on your program setting.
 Control panel for cuspidor If your dental unit includes a control panel, you can use the buttons on the control panel to operate and program bowl rinse and cup filler functions:

DENTAL UNIT

Cup filler button:
 — Press the cup filler button for a timing water supply. The factory preset time is 3 seconds while the longest programmable timing is 99 seconds. Or
 — Press and hold the cup filler button for manual operation.

Bowl Rinsing button:
 Press the bowl rinsing button for a timing bowl rinsing operation. The factory preset time is 3 minutes while the programmable timing can be selected amount 3, 15 or 60 minutes.

7.1.1 To reprogram the timed cup filler or bowl rinsing functions:

- Press **SET** on the control panel, then its indicator lights up.
- When programming timing of cup filler, press cup filler button to the time required and then release the button. Or when programming timing of Bowl Rinsing, press and release the Bowl Rinsing button 1-3 times which respectively corresponding timing of 3 minutes, 15 minutes and 60 minutes.
- Press **SET** on the control panel, then its indicator extinguishes. You'll hear one beep confirming the program has changed.

7.2 BOWL RINSING FLOW ADJUSTMENT



Cup filler regulator
 Bowl rinsing regulator

Adjustment of the bowl rinsing water flow must be carried out in the water unit. Steps for adjustment:
 1. Turn on the spittoon Flush function and adjust the water regulator clockwise or counterclockwise to adjust the water flow.

7.3 CLEANING AND MAINTENANCE



Spittoon

The contoured drain pipe and smooth spittoon are good for quick and easy cleaning. Remember to empty and clean the bowl filter every time you clean the spittoon.

CAUTION
 Do not empty the wastes of the suction filter or spittoon filter into your spittoon. Doing so could clog the spittoon drain. After cleaning, always put back the filter to the spittoon bowl to prevent from clogging the drain.

Gravity drain cleaning

At the end of each day, flush the spittoon to remove debris from the flexible drain pipe. If the spittoon is not flushed regularly, debris may build up and impair draining. To flush the spittoon, run the bowl rinse for about 60 seconds.

Maintenance parts

To replacement spittoon bowl filter, product service is available through your local authorized ours dealer.

8. OPERATING LIGHT



Operating light can be operated through sensor switch or manual switch. For detailed usage, please refer to the instructions of the operating light.

8.1 OPERATING LIGHT MAINTENANCE

⚠ CAUTION

The lipa on the hands may affect the performance of operating light and severely limiting its use life. Use only soap and water to clean the shield. Do not allow alcohol-based solutions or other chemical disinfectants to come into contact with the dental light shield. These solutions and chemicals will shorten its life.

⚠ WARNING

To avoid affecting the performance and life of the operating light, allow it to cool before cleaning the light shell. Never operate the light when cleaning.

⚠ CAUTION

Infrared sensor can not turn on operating light if operating light button on the control panel is off. For optimal performance and maximum life of your dental light shell, use only soap and water to clean the shield. Do not use alcohol-based solutions.

8.2 Steps for setting the brightness of the operating light:

- (1) Move the light to the front vertical distance from the patient chair backrest 70 cm and turn on the light to vertical illuminate the backrest of the chair.
- (2) In the vertical distance, the infrared sensing port does not exceed 5 cm, and use hand continues to sense. The brightness first drops to the lowest value and then rises to the highest value.
- (3) Observe the light source on the backrest and remove your hand when the brightness is appropriate. The program will automatically memory the brightness.

8.3 Follow these steps to remove and clean the shield:

- (1) Turn off the light and allow it to cool completely.
- (2) clean the shell with a non-abrasive, lint-free cloth which immerse in a small amount of mild, non-abrasive liquid soap and warm water.
- (3) Wash out the soap ingredients in lint-free cloth with warm water and clean the shell again.
- (4) Dry the shell with a lint-free cloth. Ensure that the shell is completely dry before turning on the operating light.

⚠ WARNING

Before performing maintenance or repairs on the lamp. Please turn off the lamp and allow it to cool completely

⚠ CAUTION

If the light shell is damaged, please contact your local authorized dealer for replacement .

Operating light use LED light source technology. For replacement, product service is available through your local authorized dealer.

⚠ WARNING

Do not install LED light source that has been damaged. Do not operate the operating light when LED light source has been damaged. Please contact your local authorized dealer for product service and replace the damaged LED light source before using the operating light.

8.3 Operating light replacement parts

Contact your local authorized dealer for available operating light maintenance parts.

9. SUGGESTION FOR CLEANING AND HYGIENE

9.1 Cleaning suggestions before operation



Microorganisms can grow in the water lines of the treatment center. Use a large amount of water for rinsing the lines prior to starting patient appointments.

9.2 Cleaning and maintenance of dental handpiece pipe lines



Use the chip-blow function to exhaust the water from the handpiece pipe lines quickly. Follow these steps to exhaust water from the pipeline after treatment to each patient:

- (1) Disconnect the handpiece from the pipe line.
- (2) Put the handpiece pipe line in a sink, cuspidor or basin.
- (3) Step on the chip-blow switch for 20-30 seconds.

DENTAL UNIT

9.3 Instructions for Reprocessing of nozzle, 3-way syringe and high power suction

WARNING

All syringe nozzles are considered critical items and must be steam sterilized or disposed off after each use. Always clean the syringe nozzle before sterilization.

Advice:	Reprocessing procedures have only limited implications to this dental instrument. The limitation of the numbers of reprocessing procedures is therefore determined by the function / wear of the device. From the processing side there is no maximum number of allowable reprocessing. The device should no longer be reused in case of signs of material degradation. In case of damage the device should be reprocessed before sending back to the manufacturer for repair or scrapped.
Reprocessing Instructions	
Preparation at the Point of Use:	Disconnect the 3-way syringe from the tube. Remove gross soiling of the instrument with cold water (<40°C) immediately after use. Don't use a fixating detergent or hot water (>40°C) as this can cause the fixation of residuals which may influence the result of the reprocessing process. Store the instruments in a humid surrounding.
Transportation:	Safe storage and transportation to the reprocessing area to avoid any damage and contamination to the environment.
Preparation for Decontamination:	The devices must be reprocessed in a disassembled state.
Pre-Cleaning:	Do a manual pre-cleaning, until the instruments are visually clean. Submerge the instruments in a cleaning solution and flush the lumens with a water jet pistol with cold tap water for at least 10 seconds. Clean the surfaces with a soft bristle brush.
Cleaning:	Regarding cleaning/disinfection, rinsing and drying, it is to distinguish between manual and automated reprocessing methods. Preference is to be given to automated reprocessing methods, especially due to the better standardizing potential and industrial safety. Automated Cleaning: Use a washer-disinfector meeting the requirements of the ISO 15883 series. Put the instrument into the machine on a tray. Connect the instrument with the WD by using suitable adapter and start the program: ●4 min pre-washing with cold water (<40°C); ●emptying ●5 min washing with a mild alkaline cleaner at 55°C ●emptying ●3 min neutralising with warm water (>40°C); ●emptying ●5 min intermediate rinsing with warm water (>40°C) ●Emptying The automated cleaning processes have been validated by using 0.5% neodisher MediClean forte (Dr. Weigert). Note: Acc. to EN ISO 17664 no manual reprocessing methods are required for these devices. If a manual reprocessing method has to be used, please validate it prior to use.
Disinfection:	Automated Drying: Drying of outside of instrument through drying cycle of washer/disinfector. If needed, additional manual drying can be performed through lint free towel. Insufflate cavities of instruments by using sterile compressed air.
Drying:	Automated Drying: Drying of outside of instrument through drying cycle of washer/disinfector. If needed, additional manual drying can be performed through lint free towel. Insufflate cavities of instruments by using sterile compressed air.
Functional Testing, Maintenance:	Visual inspection for cleanliness of the instruments and reassembling. Functional testing according to instructions of use. If necessary, perform reprocessing process again until instrument is visibly clean. Before packaging and autoclaving, make sure that the 3-way syringe has been maintained acc. to manufacturer's instruction.
Packaging:	Pack the instruments in an appropriate packaging material for sterilization. The packaging material and system refer to EN ISO 11607.
Sterilization:	Sterilization of instruments by applying a fractionated pre-vacuum steam sterilization process (according to EN 285/EN 13060/EN ISO 17665) under consideration of the respective country requirements. Minimum requirements: 3 min at 134 °C (in EU: 5 min at 134 °C) Maximum sterilization temperature: 137°C Flash sterilization is not allowed on lumen instruments!
Storage:	Storage of sterilized instruments in a dry, clean and dust free environment at modest temperatures, refer to label and instructions for use.
Reprocessing validation study information:	The above-mentioned reprocessing process (cleaning, disinfection, sterilization) has been successfully validated. Refer to test reports: -Foshan Gladent_Cleaning Disinfection Validation Report_3-way syringe -Foshan Gladent_Sterilization Validation Report_3-way syringe
Additional Instructions: None	
It is the duty of the user to ensure that the reprocessing processes including resources, materials and personnel are capable to reach the required results. State of the art and often national law requiring these processes and included resources to be validated and maintained properly.	

DENTAL UNIT

9.4 Touch and transfer surfaces

NOTE

Leave at least 20-30 seconds between each treatment to the patient in order to completely empty the water and air from the pipeline. Handpiece used is required to be with anti flow function.

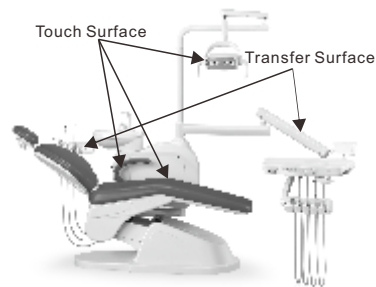

Touch surfaces are those areas that come into contact with hands and become potential cross-contamination points during dental procedure.

Transfer surfaces are those surfaces that are contaminated by contact with instruments and other inanimate objects.

We recommend barrier protection for all applicable touch and transfer surfaces. When used, barriers must be produced under the relevant legal provisions to countries/regions for protection. Refer to your national regulatory authorities for barrier recommendations specific to your location.

Barrier plastics should be removed and discarded after each patient treatment.

9.5 ADDITIONAL PERIODIC SYSTEM MAINTENANCE

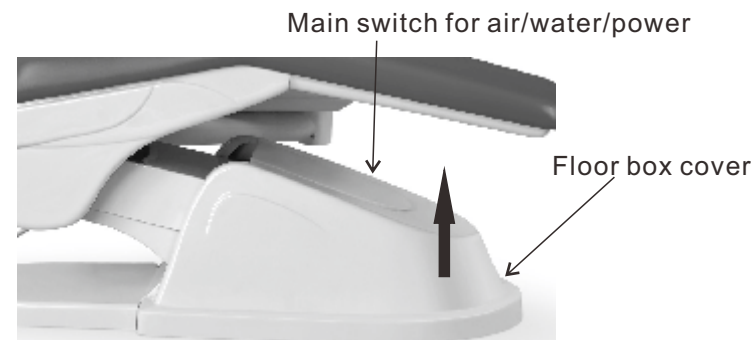

- (1) The water and air inlets are located under the jointion box cover of the chair. Pull the floor box cover up to access the inlets.
- (2) The master-control lever is to control the air and water source to the dental unit. To prevent leakage, these valves should remain fully open during use, except while your system is under maintenance.
- (3) Air and water will flow through the respective filters, when the filter is blocked or the water flow is restricted, please replace the filter.

DENTAL UNIT

9.5.1 To check for a clogged air or water filter:



Water filter

Air filter

1. Turn on the master-control lever.
2. Press the syringe air button and observe the air pressure meter, if the air pressure drops more than 0.10 MPa, the air filter needs to be replaced.
3. Press the flush button, if the flushing water pressure reduces or if the water flow stops, the water filter needs to be replaced.

9.5.2 Steps to check and replace the filter:

- (1) Turn off the master control lever.
- (2) Exhaust the air and water from the pipelines by pressing the syringe buttons until air and water no longer sprays out.
- (3) Remove the filter housing and take out the filter cartridge.
- (4) Replace the filter cartridge if it is clogged or contaminated.

⚠ CAUTION

To ensure proper operation of the delivery system, the filter housing shall be completely sealed during installation.

10. INTRODUCTION OF EMC

EMC

⚠ ATTENTION

- (1)The GD-S200、GD-S300、GD-S350、GD-S450、GD-S600、GD-S800 dental unit comply with YY 0505 standard EMC requirements.
- (2)The user should install and use the EMC information provided by the random document.
- (3)Portable and mobile RF communication devices may affect the performance of GD-S200、GD-S300、GD-S350、GD-S450、GD-S600、GD-S800 dental unit, which can be used to avoid strong electromagnetic interference, such as proximity to mobile phones and microwave ovens.
- (4)Please see the attachment for the guide and manufacturer's statement.

⚠ CAUTION

- (1)GD-S200、GD-S300、GD-S350、GD-S450、GD-S600、GD-S800dental unit should not be used or stacked with other equipment, if you have to close or stacked use, you should observe the verification in the use of its configuration can be normal operation.
- (2)In addition to the cables sold by the manufacturer of the GD-S200、GD-S300、GD-S350、GD-S450、GD-S600、GD-S800dental unit as a spare part for internal components, the use of prescribed accessories and cables may result in increased or increased immunity from the dental unit.

DENTAL UNIT

10.1 Cable information :

NO.	NAME	cable length(m)	Shield or not
1	Power supply cable	1.8	NO
2	Foot switch cable	1.5	YES

10.2 EMC Electromagnetic compatibility instructions

The recommended separation distance between portable and mobile RF communication equipment and dental unit

The GD-S200/GD-S300/GD-S350/GD-S450/GD-S600/GD-S800 dental unit is expected to be used in radioactive radiation harassment controlled electromagnetic environment. Communications equipment based on maximum rated power output, the purchaser or user can prevent electromagnetic interference by maintaining the minimum distance between the portable and mobile radio frequency communication equipment (transmitter) and the dental unit by the following recommendation.

The maximum output power of the transmitter W	The distance between the different frequencies of the transmitter/m		
	150 kHz 80 MHz $d = 1.2\sqrt{P}$	80 MHz 800 MHz $d = 1.2\sqrt{P}$	800MHz 2.5G Hz $d = 2.3\sqrt{P}$
0.01			
0.1	0.12	0.12	0.23
1	0.38	0.38	0.73
10	3.8	3.8	7.3
100	12	12	23

For the maximum rated output power of the transmitter not listed in the table above, the recommended isolation distance d in meters (m) can be determined using the formula in the corresponding transmitter frequency bar where P is the transmitter provided by the transmitter manufacturer. The maximum rated output power of the machine is in watts (W). Note 1: At frequencies above 80 MHz and 800 MHz, a higher frequency band is used. Note 2: These guidelines may not be suitable for all situations. Electromagnetic transmission is affected by the absorption and reflection of buildings, objects and human body.

DENTAL UNIT

Guide and manufacturer's statement Electromagnetic immunity			
The GD-S200/GD-S300/GD-S350/GD-S450/ GD-S600/GD-S800 dental unit is expected to be used in the electromagnetic environment specified below, and the purchaser or user should ensure that it is used in this electromagnetic environment.			
Immunity test	IEC 60601 The test level	Match level	Electromagnetic environment - Guide
Electrostatic discharge GB/T 17626.2	±6 kV contact discharge ±8 kV air discharge	±6 kV contact discharge ±8 kV air discharge	The ground should be wood, concrete or tiles, and if the ground is covered with synthetic material, the relative humidity should be at least 30%.
Fast transient bursts GB/T 17626.4	±2 kV for the power cord ±1 kV for input / output lines	±2 kV for the power cord ±1 kV for input / output lines	The network power supply should have a typical commercial or hospital environment to use the quality
Surge GB/T 17626.5	±1 kV line to line ±2 kV line to ground	±1 kV line to line ±2 kV line to ground	The network power supply should have a typical commercial or hospital environment used in the quality
The power input line voltage sag and short supply interruption and the voltage change GB/T 17626.11	<5% UT, Continuous 0.5 cycles (On UT, > 95% of the sag) 40% UT, Continuous 5 cycles (On UT, 60% of the sag) 70% UT, Continuous 25 cycles (On UT, 30% of the sag) <5% UT, Continuous 5S (On UT, >95% of the sag)	<5% UT, Continuous 0.5 cycles (On UT, > 95% of the sag) 40% UT, Continuous 5 cycles (On UT, 60% of the sag) 70% UT, Continuous 25 cycles (On UT, 30% of the sag) <5% UT, Continuous 5S (On UT, >95% of the sag)	The network power supply should have a typical commercial or hospital environment used in the quality. If the user of the dental treatment machine needs to run continuously during the power interruption, it is recommended that the dental unit be powered by uninterruptible power supply or battery
Frequency magnetic field (50/60 Hz) GB/T 17626.8	3 A/m	3 A/m, 50/60 Hz	The frequency magnetic field should have the frequency characteristics of the frequency field in a typical commercial or hospital environment.
Radio frequency conduction GB/T 17626.6 Radio frequency radiation GB/T 17626.3	3 V Valid values 150 kHz 80 MHz 3 V/m 80 MHz 2.5 GHz	3 V Valid values 3 V/m	Portable and mobile radio-frequency communication equipment should not be used in any part of the dental unit, including cables, than recommended. The distance is calculated by the formula corresponding to the frequency of the transmitter. Recommended isolation distance d = 1.2P d = 1.2 P 80 MHz-800 MHz d = 2.3 P 800 MHz-2.5 GHz Above formula: P—According to the maximum rated output power of the transmitter supplied by the transmitter manufacturer in watts(W); d—Recommended isolation distance in meters(m) b. The field strength of the fixed RF transmitter is determined by the survey of the electromagnetic field, which is lower in each frequency range than the coincidence level. Interference may occur near the device marking the following symbols.
<p>Note 1: At frequencies above 80 MHz and 800 MHz, a higher frequency band is used.</p> <p>Note 2: These guidelines may not be suitable for all situations. Electromagnetic transmission is affected by the absorption and reflection of buildings, objects and human body.</p> <p>Note a: Stationary transmitter, such as wireless (cellular / cordless) telephones and terrestrial mobile radio base stations, amateur radio, AM and FM radio and television broadcasts, are not reasonably predictable in theory. In order to evaluate the electromagnetic environment of fixed RF transmitters, the investigation of electromagnetic sites should be considered. If the field strength of the place where the dental unit is located is higher than the applicable RF compliance level, the dental unit should be observed to verify its normal operation. If abnormal performance is observed, the supplement may be necessary, such as reorienting the direction or position of the dental unit.</p> <p>Note b: The field intensity should be less than 3V/m at the entire frequency range of 150 kHz ~ 80 MHz.</p>			
Note: UT refers to the communication network voltage before the test voltage applied.			

DENTAL UNIT

Guide and manufacturer's statement Electromagnetic emission		
The GD-S200/GD-S300/GD-S350/GD-S450/GD-S600/GD-S800 dental unit is expected to be used in the electromagnetic environment specified below, and the purchaser or user should ensure that it is used in this electromagnetic environment.		
Launching test	Compliance	Electromagnetic environment - Guide
Radio frequency launch GB 4824	Group 1	The dental unit uses RF energy only for its internal functions. As a result, its RF emission is very low, and the possibility of interference with nearby electronic equipment is very small.
Radio frequency launch GB 4824	Class B	The dental units suitable for use in all facilities, including domestic facilities and direct connection to public residential low voltage power supply network.
Harmonic emission GB 17625.1	Class A	
Voltage fluctuation/ flashing emission GB 17625.2	Conform	

11. WARRANTY

We warrants all products against defects in materials or workmanship for one year from time of delivery.

We sole obligation under the warranty is to provide parts for the repair, or at its option, to provide the replacement product (excluding labor). The buyer shall have no other remedy. All special, incidental, and coincidental damages are excluded.

The warranty does not cover damage resulting from improper installation or maintenance, accident or misuse.

The warranty does not cover damage resulting from the use of cleaning, disinfecting or sterilization chemicals and processes.

The warranty also does not cover light source. Failure to follow instructions provided in the Instructions For Use (operation and maintenance instructions) may void the warranty.

No other warranties as to merchantability or otherwise are made. For service information, contact your local authorized dealer. Check with local codes for installation of this product

WARNING

According to the intended use of the device, The dental therapy unit produced by ours is a kind of dental equipment which specially produced and provided to qualified person using in the dental clinical use and related operating steps.

12. CIRCUIT SCHEMATIC DIAGRAM

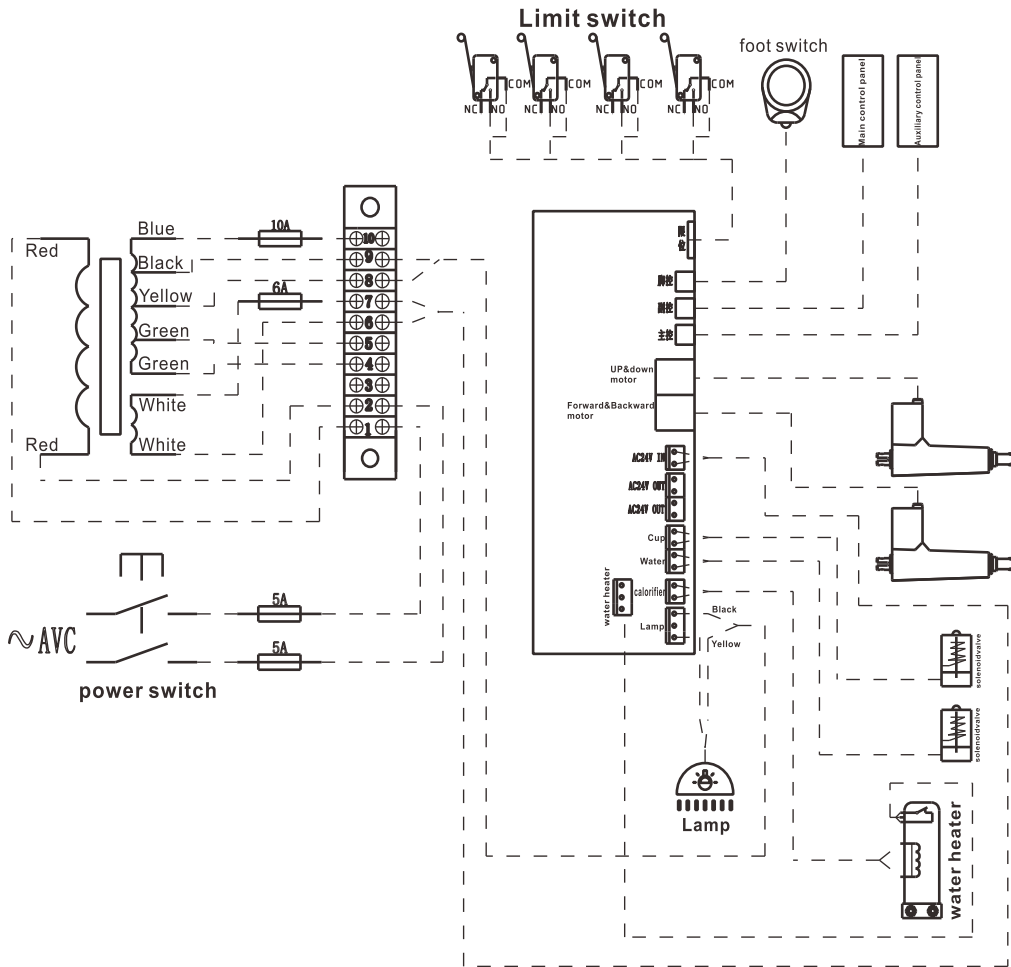

13. WATER GAS CONNECTION DIAGRAM

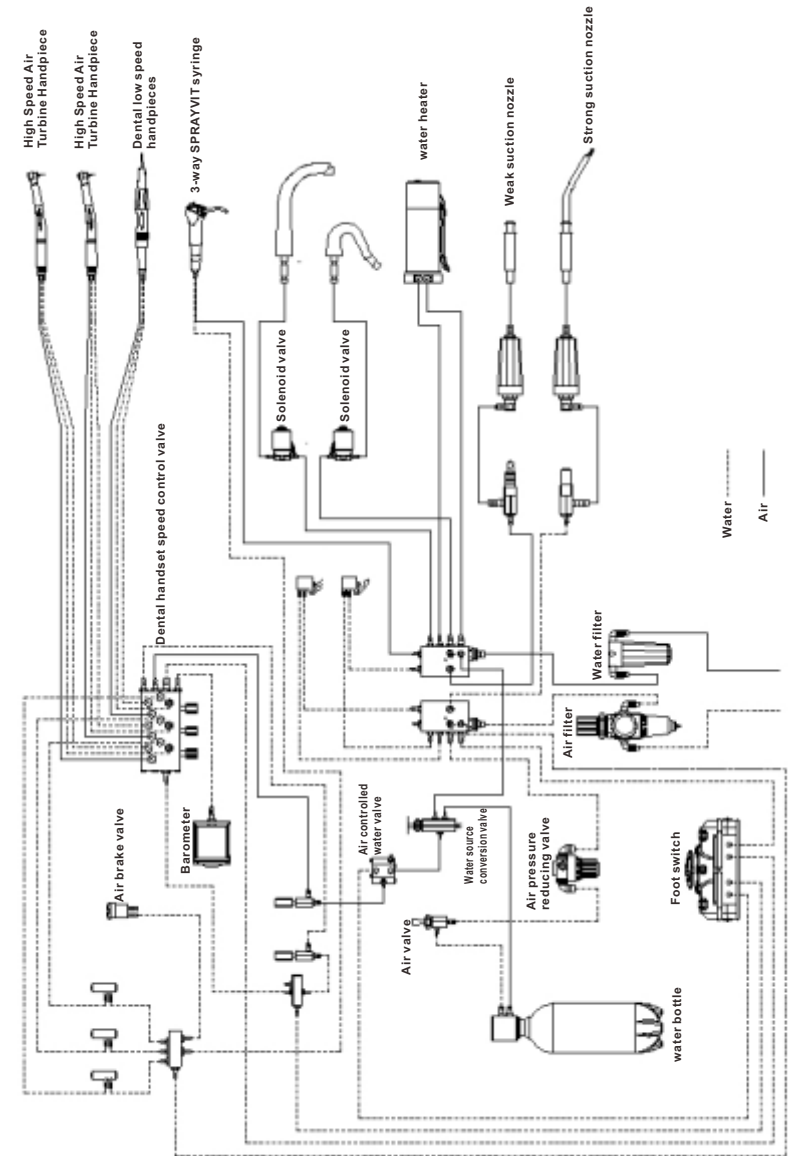

14 . TROUBLESHOOTING

Phenomenon	Cause analysis	Troubleshooting	Note column
Dental lamp is not on	(1)Burn out the light bulb (2)Bad contact of plug (3)Fuses burn out (4)The power cord inside the joint is broken	(1)Replace the same type of light bulb (2)Plug the plug with a tool (3)Replacement fuse (4)Replace the power line	AC12V 50W
Water supply water can not be closed	The interior of the solenoid valve to the foreign object card owner	Disassemble the spool	
The spittoon can't come out of water	(1)Pipe distortion (2)Solenoid valve burnout	(1)Tidy water pipe (2)Replacement of the solenoid valve	
Suction system has no suction	(1)Water pressure and air pressure do not meet the requirements of use (2)The inside of the suction tube is blocked (3)Failure of negative pressure generator	(1)Check water pressure and pressure (2)Cleaning the inside of the suction tube (3)Replacement negative pressure generator	

15. PACKING AND ACCESSORIES LIST

mode	name	QTY	unit
1	Host computer	1	pcs
2	Oral lamp	1	pcs
3	blance arm	1	set
4	column	1	pcs
5	3-way syringe equipment	1	set
6	Disposable saliva suction nozzle	2	pcs
7	Flushing sets	1	pcs
8	Water set	1	pcs
9	user's manual	1	pcs
10	Certificate	1	pcs
11	dental stool	1	pcs
12	Fuse	4	pcs